

Series 10-IRV10/20 Vacuum Regulator

RoHS

How to Order

Standard connections 10-IRV [] - [] C08 [] []

Clean series

Body size

10	Max. flow 140 L/min (ANR)
20	Max. flow 240 L/min (ANR)

Fittings

Nil	Straight
L	Elbow

Accessory ②

Nil	None Note 1)	
G	With pressure gauge Note 2) Note 3) (10-IRV10: With GZ33-K-01-X5, 10-IRV20: With GZ43-K-01-X5)	
ZN	Note 3) With digital pressure switch	NPN open collector 1 output With ZSE30A-01-N-ML
ZP		PNP open collector 1 output With ZSE30A-01-P-ML
ZA		NPN open collector 2 outputs With ZSE30A-01-A-ML
ZB		PNP open collector 2 outputs With ZSE30A-01-B-ML

Note 1) Two plug nuts are mounted.
Note 2) Pressure gauge accuracy: Within ±3% of full scale
Note 3) Plug nut and gauge nut are included. (For details, refer to back page 3 in CAT. ES60-20.) Accessories are included in the same container.

Accessory ① Note 1)

Nil	None
B	With bracket
L	With bottom bracket

Note 1) Accessories are shipped together.



Straight



Elbow

Connection tubing O.D.

Symbol	Tubing O.D.	10-IRV10	10-IRV20
C06		●	●
C08	Metric	●	●
	ø8	●	●
C10		—	●
	ø10	—	●
N07		●	●
	ø1/4"	●	●
N09	Inch	●	●
	ø5/16"	●	●
N11		—	●
	ø3/8"	—	●

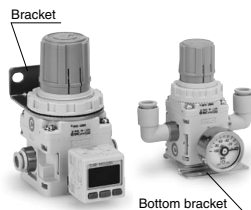

Bracket

Bottom bracket

Single sided connections 10-IRV 20 A - [] C08 [] []

Clean series

Body size

10	Max. flow 140 L/min (ANR)
20	Max. flow 240 L/min (ANR)

Single sided connections

A	Single sided connections
---	--------------------------

Fittings

Nil	Straight
L	Elbow

Accessory ②

Nil	None Note 1)	
G	With pressure gauge Note 2) Note 3) (10-IRV10A: With GZ33-K-01-X5, 10-IRV20A: With GZ43-K-01-X5)	
ZN	Note 3) With digital pressure switch	NPN open collector 1 output With ZSE30A-01-N-ML
ZP		PNP open collector 1 output With ZSE30A-01-P-ML
ZA		NPN open collector 2 outputs With ZSE30A-01-A-ML
ZB		PNP open collector 2 outputs With ZSE30A-01-B-ML

Note 1) A plug nut is mounted.
Note 2) Pressure gauge accuracy: Within ±3% of full scale
Note 3) Gauge nut is included. Accessories are included in the same container.

Accessory ① Note 1)

Nil	None
B	With bracket
L	With bottom bracket

Note 1) Accessories are shipped together.



Elbow



Straight

Connection tubing O.D.

Symbol	Tubing O.D.	10-IRV10A	10-IRV20A
C06		●	●
C08	Metric	●	●
	ø8	●	●
C10		—	●
	ø10	—	●
N07		●	●
	ø1/4"	●	●
N09	Inch	●	●
	ø5/16"	●	●
N11		—	●
	ø3/8"	—	●

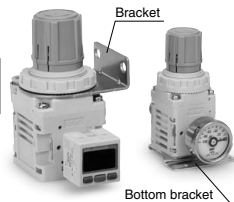

Bracket

Bottom bracket

Directional Control Valves

Air Cylinders

Rotary Actuators

Air Grippers

Air Preparation Equipment

Modular F. R.

Pressure Control Equipment

Fittings & Tubing

Flow Control Equipment

Pressure Switches/ Pressure Sensors

Standard Specifications

Model		10-IRV10	10-IRV20
Fluid		Air	
Set pressure range ^{Note 1)}		-100 to -1.3 kPa	
Atmospheric intake consumption ^{Note 2)}		0.6 L/min (ANR) or less	
Knob resolution		0.13 kPa or less	
Ambient and fluid temperature		5 to 60°C	
VAC side tubing O.D.		ø6, ø8 ø1/4", ø5/16"	ø6, ø8, ø10 ø1/4", ø5/16", ø3/8"
Weight (Without accessories)	Standard connections	135 g (10-IRV10-C08)	250 g (10-IRV20-C10)
	Single sided connections	125 g (10-IRV10A-C08)	250 g (10-IRV20A-C10)

Note 1) Use caution it varies depending on the pressure in vacuum pump side.

Note 2) Taking air from atmosphere all the time.

Conditions:
 Vacuum pump exhaust speed:
 2500 L/min
 VAC side pressure:
 -101 kPa (At initial setting)

Flow Rate Characteristics (Representative Value)

10-IRV10-C08 (One-touch fitting ø8)

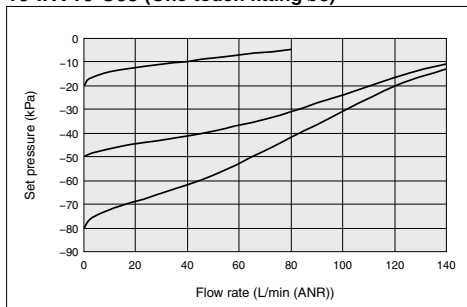

Pressure Characteristics (Representative Value)

10-IRV10

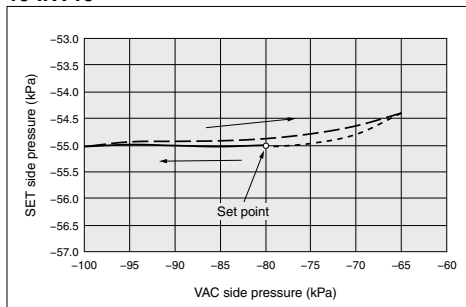

10-IRV20-C10 (One-touch fitting ø10)

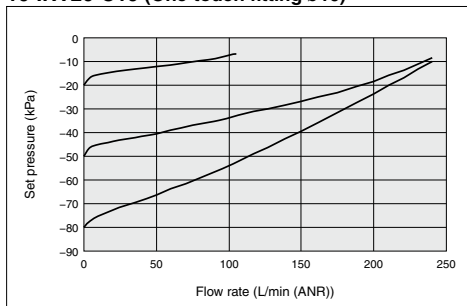

10-IRV20

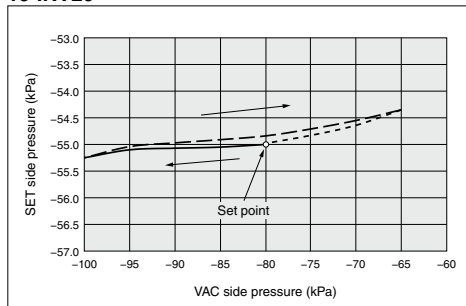

Construction

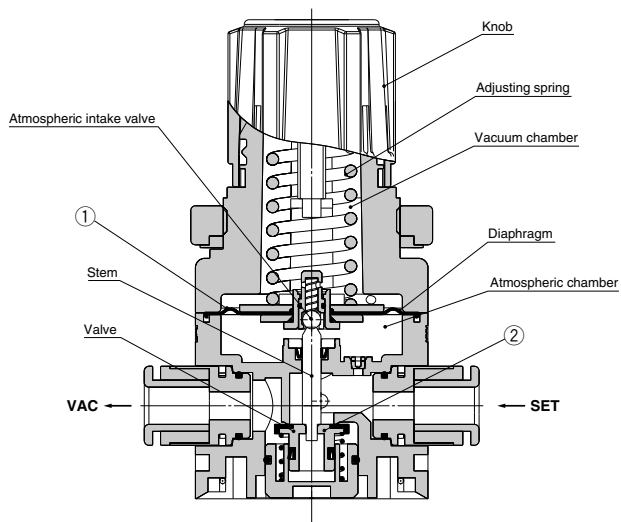

Working principle

When the knob is turned to the right (clockwise), the adjusting spring's generated force pushes down the diaphragm and the valve. This connects the VAC side and SET side, and the degree of vacuum on the SET side increases (becomes closer to an absolute vacuum). Furthermore, the SET side vacuum pressure moves through the air passage into the vacuum chamber, where it is applied to the top side of the diaphragm and counters the adjusting spring's compression force; and this adjusts the SET side pressure. When the degree of vacuum on the SET side is higher than the designated setting value (becomes closer to an absolute vacuum), the balance between the adjusting spring and the SET side pressure in the vacuum chamber is lost, and the diaphragm is pushed up. This causes the valve to close and the atmospheric intake valve to open, which lets atmospheric air into the SET side. When the adjusting spring's compression force and the SET side pressure are balanced, the SET side pressure is set. Also, when the degree of vacuum of the SET side pressure is lower than the designated setting value (becomes closer to the atmosphere), the balance between the adjusting spring and the vacuum chamber is lost, and the diaphragm is pushed down. This causes the atmospheric intake valve to close and the valve to open, which lets air into the VAC side. When the adjusting spring's compression force and the SET side pressure are balanced, the SET side pressure is set.

Replacement Parts

No.	Description	Material	Part no.	
			10-IRV10	10-IRV20
1	Diaphragm assembly	HNBR, etc.	P601010-2	P601020-2
2	Valve assembly	HNBR, etc.	P601010-3	P601020-3

Directional Control Valves

Air Cylinders

Rotary Actuators

Air Grippers

Air Preparation Equipment

Modular F. R.

Pressure Control Equipment

Fittings & Tubing

Flow Control Equipment

Pressure Switches/ Pressure Sensors

Dimensions/10-IRV10: Standard Connections

10-IRV10-□□□G: With pressure gauge

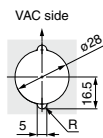
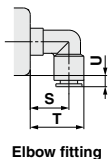
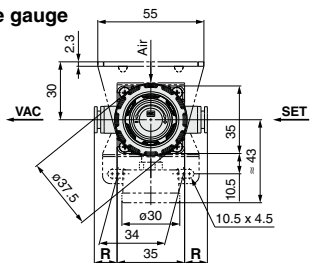

Elbow fitting

Panel cut
Panel plate thickness:
Max. 3

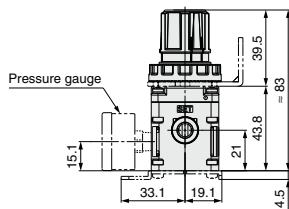
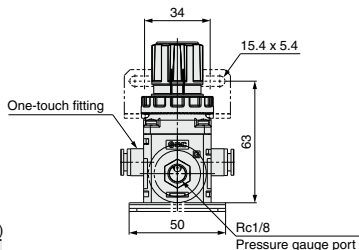

Fitting Part Dimensions (mm)

Fitting size	VAC/SET			
	Straight R	Elbow S	Elbow T	Elbow U
ø6, ø1/4"	10	19	26	3
ø8, ø5/16"	12	20	28	6

10-IRV10-□□□Z^N□□□A^B: With digital pressure switch

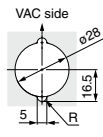
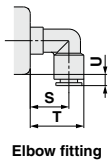
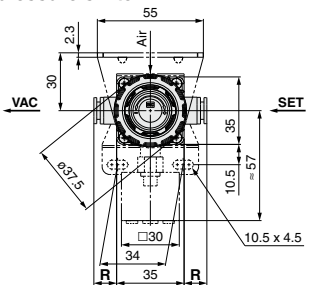

Elbow fitting

Panel cut
Panel plate thickness:
Max. 3

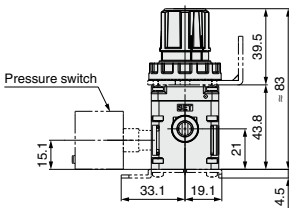
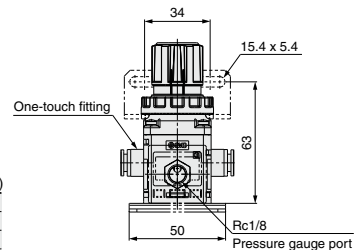

Fitting Part Dimensions (mm)

Fitting size	VAC/SET			
	Straight R	Elbow S	Elbow T	Elbow U
ø6, ø1/4"	10	19	26	3
ø8, ø5/16"	12	20	28	6

Dimensions/10-IRV10A: Single Sided Connections

10-IRV10A-□□□G: With pressure gauge

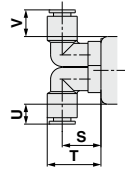
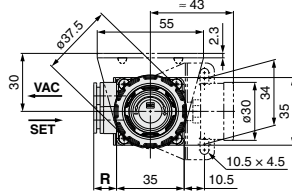

Elbow fitting

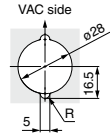

Panel cut
Panel plate thickness:
Max. 3

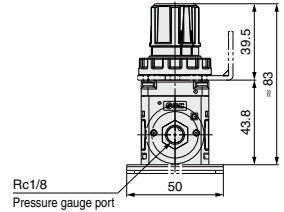
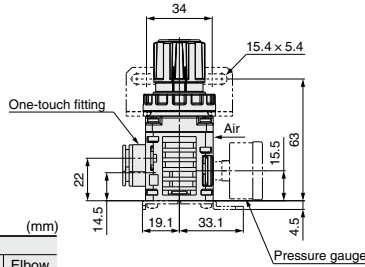

Rc1/8
Pressure gauge port

Fitting Part Dimensions

Fitting size	VAC/SET				
	Straight	Elbow	Elbow	Elbow	Elbow
	R	S	T	U	V
ø6, ø1/4"	10	19	26	7.5	11
ø8, ø5/16"	12	20	28	10.5	14

10-IRV10A-□□□Z^N_A□□□_B: With digital pressure switch

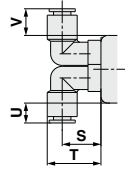
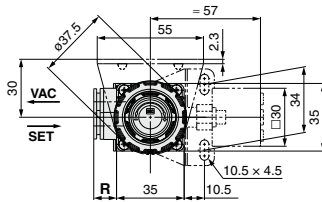

Elbow fitting

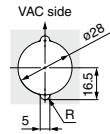

Panel cut
Panel plate thickness:
Max. 3

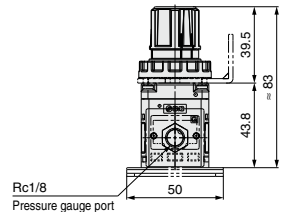
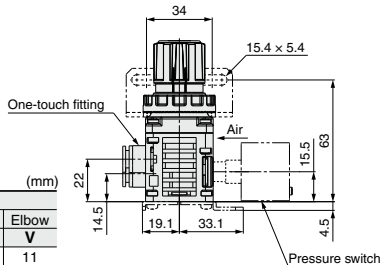

Rc1/8
Pressure gauge port

Fitting Part Dimensions

Fitting size	VAC/SET				
	Straight	Elbow	Elbow	Elbow	Elbow
	R	S	T	U	V
ø6, ø1/4"	10	19	26	7.5	11
ø8, ø5/16"	12	20	28	10.5	14

Directional Control Valves
Air Cylinders
Rotary Actuators
Air Grippers
Air Preparation Equipment
Modular F. R.
Pressure Control Equipment
Fittings & Tubing
Flow Control Equipment
Pressure Switches/
Pressure Sensors

Dimensions/10-IRV20: Standard Connections

10-IRV20-□□□G: With pressure gauge

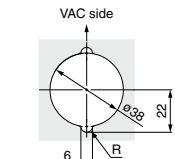
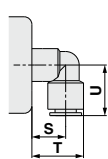
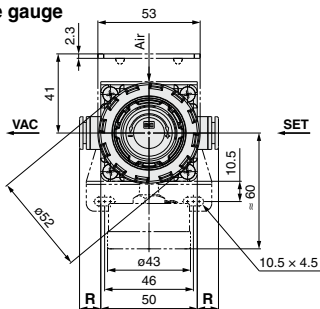

Elbow fitting

Panel cut
Panel plate thickness:
Max. 4

Fitting Part Dimensions (mm)

Fitting size	VAC/SET			
	Straight R	Elbow S	Elbow T	Elbow U
ø6	10.5	21	27.5	21
ø1/4"	10.5	21	27.5	21.5
ø8, ø5/16"	10.5	21	28.5	24
ø10, ø3/8"	11	21	30.5	27

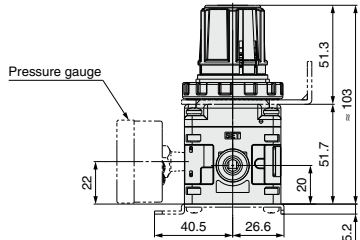
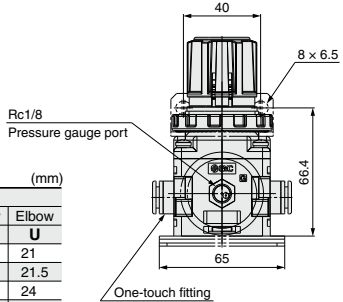

One-touch fitting

10-IRV20-□□□^N□□_A□^P□^B: With digital pressure switch

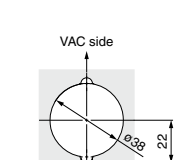
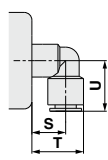
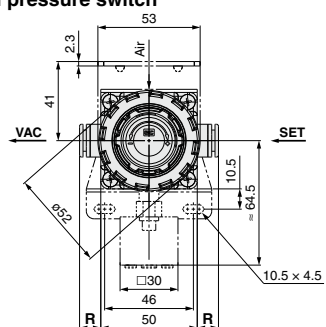

Elbow fitting

Panel cut
Panel plate thickness:
Max. 4

Fitting Part Dimensions (mm)

Fitting size	VAC/SET			
	Straight R	Elbow S	Elbow T	Elbow U
ø6	10.5	21	27.5	21
ø1/4"	10.5	21	27.5	21.5
ø8, ø5/16"	10.5	21	28.5	24
ø10, ø3/8"	11	21	30.5	27

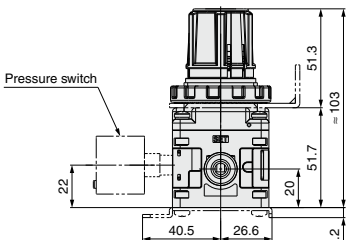
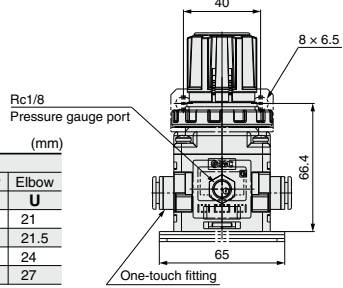

One-touch fitting

Dimensions/10-IRV20A: Single Sided Connections

10-IRV20A-□□□G: With pressure gauge

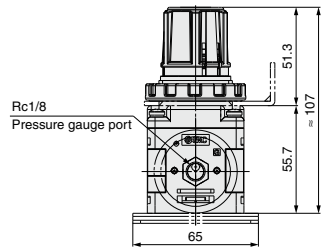
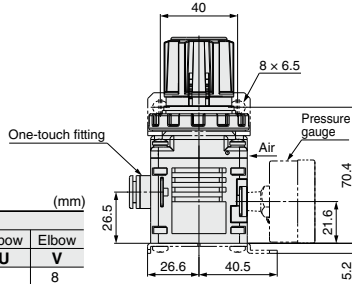
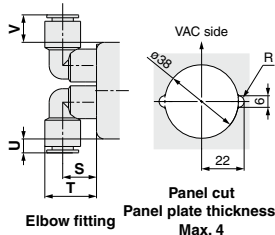
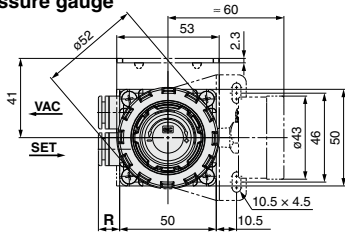

Fitting Part Dimensions

Fitting size	VAC/SET (mm)				
	R	S	T	U	V
ø6	10.5	21	27.5	1	8
ø1/4"	10.5	21	27.5	1.5	8.5
ø8, ø5/16"	10.5	21	28.5	4	11
ø10, ø3/8"	11	21	30.5	7	14

10-IRV20A-□□□Z: With digital pressure switch

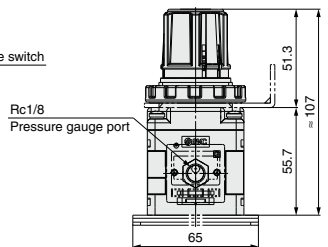
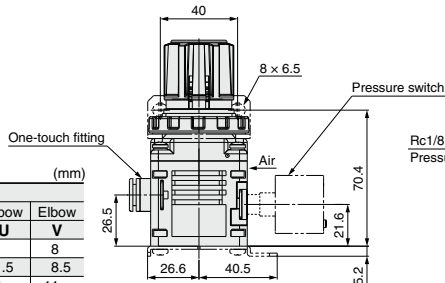
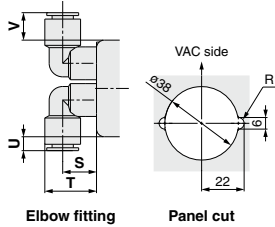
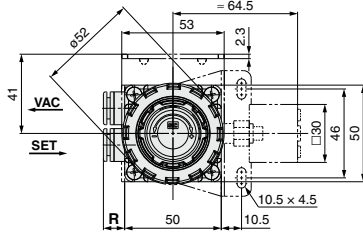

Fitting Part Dimensions

Fitting size	VAC/SET (mm)				
	R	S	T	U	V
ø6	10.5	21	27.5	1	8
ø1/4"	10.5	21	27.5	1.5	8.5
ø8, ø5/16"	10.5	21	28.5	4	11
ø10, ø3/8"	11	21	30.5	7	14

- Directional Control Valves
- Air Cylinders
- Rotary Actuators
- Air Grippers
- Air Preparation Equipment
- Modular F. R.
- Pressure Control Equipment
- Fittings & Tubing
- Flow Control Equipment
- Pressure Switches/Pressure Sensors



Series 10-IRV10/20 Specific Product Precautions

Be sure to read this before handling. Refer to page 1382 for Safety Instructions.

Handling

Warning

1. When a system hazard can be expected due to a drop in vacuum pressure caused by power loss or vacuum pump trouble, install a safety circuit and configure the system so that it can avoid the danger.
2. When a system hazard can be expected with trouble with the vacuum regulator, install a safety circuit and configure the system so that it can avoid the danger.

Operating Environment

Warning

1. Do not use in an atmosphere having corrosive gases, chemicals, sea water, water, water steam, or where there is direct contact with any of these.
2. Do not use in locations influenced by vibrations or impacts.
3. This vacuum regulator always uses atmospheric air, therefore, do not use in dusty environments.
4. In locations which receive direct sunlight, provide a protective cover etc.
5. In locations near heat sources, block off any radiated heat.

Vacuum Supply

Caution

1. This vacuum regulator is not to be used for adjusting vacuum pump pressures.
2. Note that an ejector's flow rate is smaller than that of the vacuum regulator, and therefore, it is not suitable as a "vacuum supply".

Air Supply

Caution

1. These products are designed for use with air. Please contact SMC if any other fluid will be used.
2. Do not use air which includes chemicals, synthetic oils containing organic solvents, salt, or corrosive gases, etc., as this can cause malfunction.

Precautions

Caution

1. Connect piping to the port with "VAC" indication for connection to the vacuum pump.
2. To adjust the pressure, turn the knob to the right (clockwise) for changing "atmospheric pressure to vacuum pressure" and to the left (counterclockwise) for changing "vacuum pressure to atmospheric pressure".
3. When adjusting pressure, do not touch the lateral hole (atmospheric intake hole) of the body.
4. When locking the knob after setting the pressure, press down the knob until the orange band is hidden and a click is heard. On the other hand, when unlocking the knob, pull it up until the orange band is visible and a click is heard.
5. This vacuum regulator is for use with vacuum pressure only. Be sure that positive pressure is not applied instead. In the event that positive pressure is applied, the vacuum regulator will not be damaged. However, the main valve of the pressure adjustment valve will open and positive pressure will enter the vacuum pump. This may cause trouble with the vacuum pump.
6. When the vacuum pump capacity is relatively small or when the inside diameter of the piping is small, a change in the set pressure (the pressure difference between the non-flow and flow conditions) may be large. In this case, change the vacuum pump or the inside diameter of the piping. When changing the vacuum pump is not possible, add a capacity tank (the capacity depends on the operating conditions) to the VAC side.
7. The pressure response time after opening and closing of valves (such as solenoid valves) is influenced in large and small measures by the internal capacity (includes piping capacity) of the set side. Since the vacuum pump capacity also affects the response time, consider all these points before operations.
8. When using a pressure gauge upside down like Fig. 1, it may result in a shifting of the zero point reading. Make sure to use it in the direction like Fig. 2.

10-IRV10

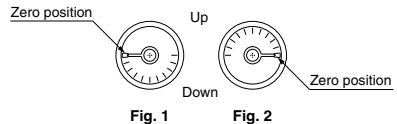

10-IRV20

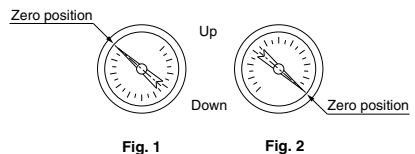

Fig. 1

Fig. 2