

Speed Controller for Low Speed Operation with One-touch Fitting Elbow Type/Universal Type (Resin Body)

AS-FM Series

RoHS

Suitable for low speed control at 10 to 50 mm/s

Since the sonic conductance of the controlled flow is approximately 1/10 that of the standard model, it is ideal for speed control of low speed cylinders at 10 to 50 mm/s. The dual type is particularly suitable for low speed control of small bore cylinders.

Low speed operating stroke and high speed return stroke drive

Sonic conductance of free flow is the same as that of standard model.

Speed control is easy, and uniform speed control is possible.

Applicable tubing: Inch sizes standardized

Inch sizes are now available for all models.



Model

Elbow type	Universal type	Port size	Applicable tubing O.D.													
			Metric size					Inch size								
			3.2	4	6	8	10	1/8"	5/32"	3/16"	1/4"	5/16"	3/8"			
AS12□1FM-M5	AS13□1FM-M5	M5 x 0.8	●	●	●											
AS22□1FM-01	AS23□1FM-01	R 1/8	●	●	●	●										
AS22□1FM-02	AS23□1FM-02	R 1/4		●	●	●	●									
AS12□1FM-U10/32	AS13□1FM-U10/32	10-32 UNF								●	●	●	●			
AS22□1FM-N01	AS23□1FM-N01	NPT 1/8								●	●	●	●	●		
AS22□1FM-N02	AS23□1FM-N02	NPT 1/4									●	●	●	●	●	

Specifications

Fluid	Air
Proof pressure	1.5 MPa
Max. operating pressure	1.0 MPa
Mini. operating pressure	0.1 MPa
Ambient and fluid temperature	-5 to 60°C (No freezing)
Applicable tubing material ⁽¹⁾	Nylon, Soft nylon, Polyurethane
Option ⁽²⁾	With seal, Round lock nut

Note 1) Use caution regarding the max. operating pressure when soft nylon or polyurethane, or soft polyurethane tubing is used.

(Refer to pages 678 and 682 for details.)

Note 2) M5 and 10-32UNF type ports are not available with seal.

Note 3) Brass parts are all electroless nickel plated. The lock nut of the meter-out type is zinc chromate plated (the round lock nut is electroless nickel plated), then, the handle of the M5 type and the lock nut of the meter-in type are black zinc chromate plated.

Flow Rate and Sonic Conductance

Model		AS12□1FM AS13□1FM	AS22□1FM-01 AS23□1FM-01	AS22□1FM-02 AS23□1FM-02
Tubing O.D.	Metric size	ø3.2,ø4,ø6	ø3.2,ø4	ø6,ø8
	Inch size	ø1/8", ø5/32", ø3/16", ø1/4"	ø1/8", ø5/32"	ø3/16", ø1/4", ø5/16"
Controlled flow	Air flow (L/min(ANR))	7	12	38
	Sonic conductance dm ³ /(s·bar)	0.02	0.04	0.12
	Critical pressure ratio	0.2	0.25	0.3
Free flow	Flow rate (L/min(ANR))	100	180	230
	Sonic conductance dm ³ /(s·bar)	0.3	0.54	0.7
	Critical pressure ratio	0.4	0.2	0.3

Note) Flow rate values are measured at 0.5 MPa and 20°C.

⚠ Caution

Be sure to read this before handling the products. Refer to page 11 for safety instructions and pages 19 to 22 for flow control equipment precautions.

Symbol

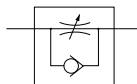

Flow Direction Symbols on Body

	Meter-out type	Meter-in type
Indication symbol		
Symbol		

Made to Order
Made to Order
(Refer to page 945 for details.)

How to Order

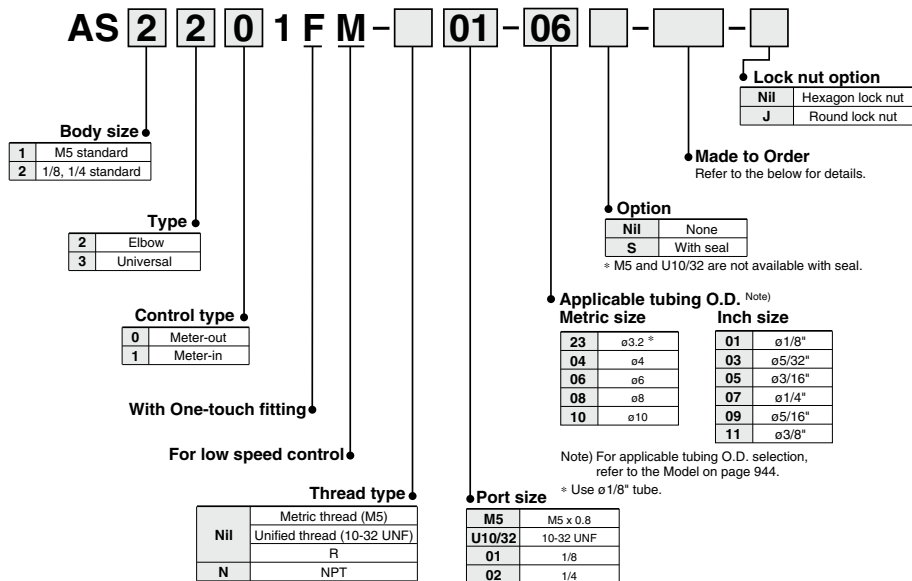

Made to Order



Lubricant: Vaseline

X12

Ex.) AS1201FM-M5-23-X12

Grease-free (Seal: Fluorine Coated) + Throttle Valve (Without Check Valve)

X21

Ex.) AS1201FM-M5-23-X21

Note 1) Not particle-free

Note 2) This product is a restrictor without a check valve (no control direction).

Be aware that all part numbers are for a meter-out type; there is no part number for a meter-in type.

Throttle Valve (Without Check Valve)

X214

Ex.) AS1201FM-M5-23-X214

Note) This product is a restrictor without a check valve (no control direction). Be aware that all part numbers are for a meter-out type; there is no part number for a meter-in type.

Needle Valve/Flow Rate Characteristics

Note) The flow rate characteristics are representative values.

AS1201FM, AS1211FM
AS1301FM, AS1311FM

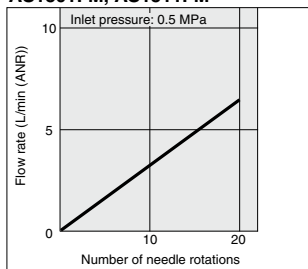

AS2201FM-□01, AS2211FM-□01
AS2301FM-□01, AS2311FM-□01

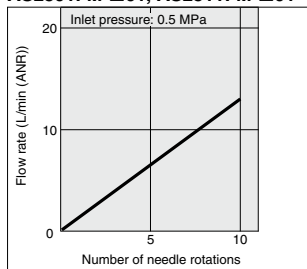

AS2201FM-□02, AS2211FM-□02
AS2301FM-□02, AS2311FM-□02

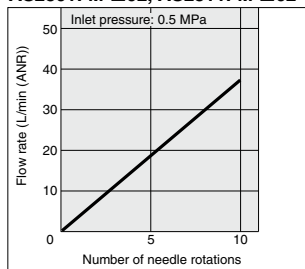

AS-FM Series

Construction: Elbow Type

Meter-out type

Symbol

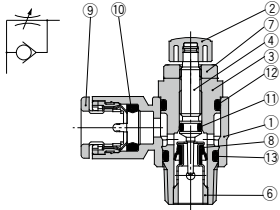

Meter-in type

Symbol

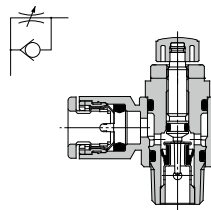

M5 type U10/32 type

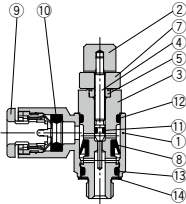

M5 type U10/32 type

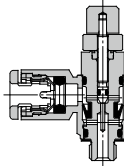

Component Parts

No.	Description	Material	Note
1	Body A	PBT	White
2	Handle	PBT	Black ⁽¹⁾
3	Body B	Brass	Electroless nickel plated
4	Needle	Brass	Electroless nickel plated
5	Needle guide	Brass	Electroless nickel plated, M5 type only
6	Seat ring	Brass	Electroless nickel plated
7	Lock nut	Steel ⁽²⁾	Meter-out Zinc chromate plated ⁽³⁾ Meter-in Black zinc chromate plated
8	U seal	HNBR	
9	Cassette	—	
10	Seal	NBR	
11	O-ring	NBR	
12	O-ring	NBR	
13	O-ring	NBR	
14	Gasket	NBR, Stainless steel	M5 type only

Note 1) M5 and U10/32 types are black zinc chromate plated.
Note 2) The material of the lock nut option-J (round type) is brass. However, note that only the AS2□1FM uses steel.

Note 3) The surface treatment of the lock nut option-J (round type) is electroless nickel plated.

Construction: Universal Type

Meter-out type

Symbol

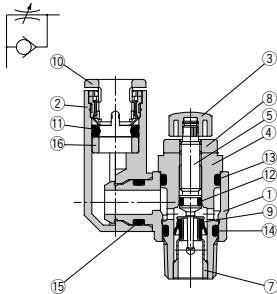

Meter-in type

Symbol

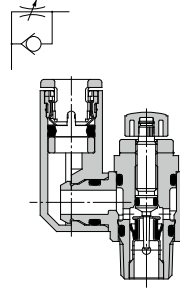

M5 type U10/32 type

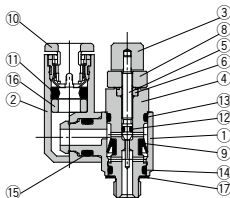

M5 type U10/32 type

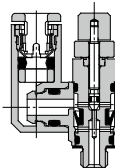

Component Parts

No.	Description	Material	Note
1	Body A	PBT	White
2	Elbow body	PBT	White
3	Handle	PBT	Black ⁽¹⁾
4	Body B	Brass	Electroless nickel plated
5	Needle	Brass	Electroless nickel plated
6	Needle guide	Brass	Electroless nickel plated, M5 type only
7	Seat ring	Brass	Electroless nickel plated
8	Lock nut	Steel ⁽²⁾	Meter-out Zinc chromate plated ⁽³⁾ Meter-in Black zinc chromate plated
9	U seal	HNBR	
10	Cassette	—	
11	Seal	NBR	
12	O-ring	NBR	
13	O-ring	NBR	
14	O-ring	NBR	
15	O-ring	NBR	
16	Spacer	—	
17	Gasket	NBR, Stainless steel	M5 type only

Note 1) M5 and U10/32 types are black zinc chromate plated.
Note 2) The material of the lock nut option-J (round type) is brass. However, note that only the AS2□1FM uses steel.

Note 3) The surface treatment of the lock nut option-J (round type) is electroless nickel plated.

Speed Controller for Low Speed Operation with One-touch Fitting Elbow Type/Universal Type (Resin Body) **AS-FM Series**

Dimensions: Elbow Type

M5 type U10/32 type

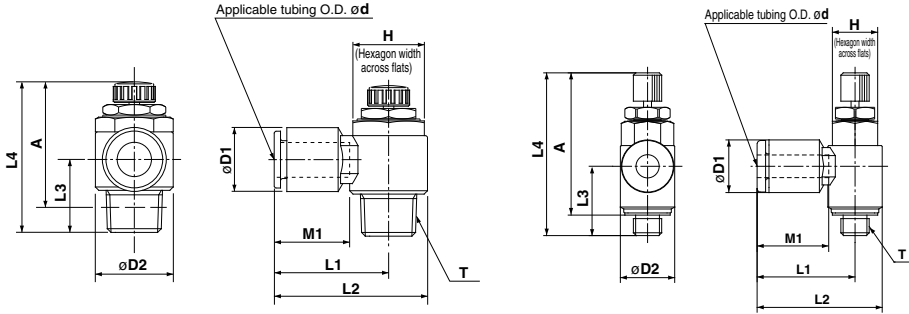

Metric Size

Model	d	T	H	D1	D2	L1	L2	L3	L4 (1)(2)		A (1)(2)		M1	Weight (g)
									Max.	Min.	Max.	Min.		
AS12□1FM-M5-23	3.2	M5 x 0.8	8	8.4	9.6	17.3	22.1	12.3	33.8	28.8	30.1	25.1	12.7	7
AS12□1FM-M5-04	4			9.3		17.3	22.1							
AS12□1FM-M5-06	6			11.6		18.1	22.9							
AS22□1FM-01-23	3.2	R 1/8	12	9.3	14.2	20.4	27.5	13.4	35.2	30.2	32.1	27.1	12.7	17
AS22□1FM-01-04	4			9.3		20.4	27.5							
AS22□1FM-01-06	6			11.6		20.4	27.5							
AS22□1FM-01-08	8			15.2		25.3	32.4							
AS22□1FM-02-04	4	R 1/4	17	10.4	18.5	25.2	34.4	17.7	39.9	34.9	34.4	29.4	16	32
AS22□1FM-02-06	6			12.8		25.2	34.4							
AS22□1FM-02-08	8			15.2		27.2	36.4							
AS22□1FM-02-10	10			18.5		35.3	44.5						18.3	

Note 1) Reference dimensions

Note 2) Reference dimensions of M5 and R threads after installation.

Inch Size

Model	d	T	H	D1	D2	L1	L2	L3	L4 (1)		A (2)		M1	Weight (g)
									Max.	Min.	Max.	Min.		
AS12□1FM-U10/32-01	1/8"	10-32 UNF	8	8.4	9.6	17.3	22.1	12.3	33.8	28.8	30.1	25.1	12.7	7
AS12□1FM-U10/32-03	5/32"			9.3		17.3	22.1							
AS12□1FM-U10/32-05	3/16"			11.4		18.3	26.1							
AS12□1FM-U10/32-07	1/4"			12		18.3	23.1						13.5	
AS22□1FM-N01-01	1/8"	NPT 1/8	12.7	9.3	14.2	20.4	27.5	13.4	35.2	30.2	32.1	27.1	12.7	16
AS22□1FM-N01-03	5/32"			9.3		20.4	27.5							
AS22□1FM-N01-05	3/16"			13.2		24	31.1							
AS22□1FM-N01-07	1/4"			13.2		23.9	31							
AS22□1FM-N01-09	5/16"			15.2		25.3	32.4	13.4					18.5	21
AS22□1FM-N02-03	5/32"	NPT 1/4	17.5	10.4	18.5	25.2	34.4	17.7	39.9	34.9	34.4	29.4	16	32
AS22□1FM-N02-05	3/16"			12.8		25.2	34.5							
AS22□1FM-N02-07	1/4"			13.2		25.2	34.5							
AS22□1FM-N02-09	5/16"			15.2		27.2	36.4						17.7	
AS22□1FM-N02-11	3/8"			18.5		35.3	44.5	18.3					18.5	36

Note 1) Reference dimensions

Note 2) Reference dimensions of 10-32 UNF and NPT threads after installation.

AS-FM Series

Dimensions: Universal Type

M5 type

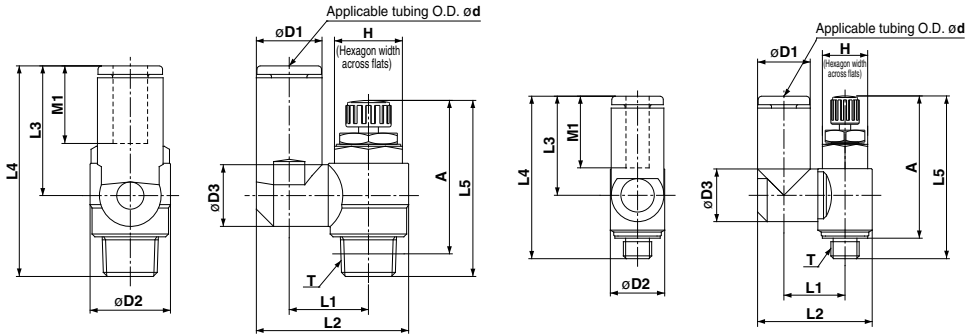

Metric Size

Model	d	T	H	D1	D2	D3	L1	L2	L3	L4	L5 (1)		A (2)		M1	Weight (g)		
											Max.	Min.	Max.	Min.				
AS13□1FM-M5-23	3.2	M5 x 0.8	8	8.4	9.6	9.3	10.8	19.8	17.5	28.7	33.8	28.8	30.1	25.1	12.7	8		
AS13□1FM-M5-04	4			9.3				20.3	20.3	20.3					20.3			
AS13□1FM-M5-06	6			11.6				21.4	20.6	31.8					21.4		31.8	
AS23□1FM-01-23	3.2	R 1/8	12	8.4	14.2	9.3	13.1	24.4	17.5	30.9	35.2	30.2	32.1	27.1	12.7	17		
AS23□1FM-01-04	4			9.3				24.9	24.9	24.9					24.9			
AS23□1FM-01-06	6			11.6				26.9	22.9	36.3					26.9		36.3	
AS23□1FM-01-08	8	15.2	15.2	30.9	28.2	40.8	12.9	16.2	30.9	28.2	40.8	12.9	16.2	30.9	28.2	40.8		
AS23□1FM-02-04	4	R 1/4	17	10.4	18.5	12.9	18.4	34	25.2	42.1	39.9	34.9	34.4	29.4	16	33		
AS23□1FM-02-06	6			12.9				18.4	34	25.2					42.1		17	17
AS23□1FM-02-08	8			15.2				18.3	35.2	28.2					45.1		18.5	36
AS23□1FM-02-10	10	18.5	20.2	38.7	31	47.9	21	40										

Note 1) Reference dimensions

Note 2) Reference dimensions of M5 and R threads after installation.

Inch Size

Model	d	T	H	D1	D2	D3	L1	L2	L3	L4	L5 (1)		A (2)		M1	Weight (g)	
											Max.	Min.	Max.	Min.			
AS13□1FM-U10/32-01	1/8"	10-32 UNF	8	8.4	9.6	9.3	10.8	19.8	17.5	28.7	33.8	28.8	30.1	25.1	12.7	7	
AS13□1FM-U10/32-03	5/32"			9.3				20.3	20.3	20.3					20.3		
AS13□1FM-U10/32-05	3/16"			11.4				21.3	23.3	34.5					21.3		34.5
AS13□1FM-U10/32-07	1/4"	12	21.6	20.7	31.9	21.6	31.9	12.7	8								
AS23□1FM-N01-01S	1/8"	NPT 1/8	12.7	8.4	14.2	9.3	13.1	24.4	17.5	30.9	35.2	30.2	32.1	27.1	12.7	17	
AS23□1FM-N01-03S	5/32"			9.3				24.9	24.9	24.9					24.9		
AS23□1FM-N01-05S	3/16"			11.4				26.8	23.9	37.3					26.8		37.3
AS23□1FM-N01-07S	1/4"	13.2	13.2	29.9	25.6	38.2	12.9	16.2	30.9	28.2	40.8	12.9	16.2	30.9	28.2	40.8	
AS23□1FM-N01-09S	5/16"	15.2	15.2	30.9	28.2	40.8	12.9	16.2	30.9	28.2	40.8	12.9	16.2	30.9	28.2	40.8	
AS23□1FM-N02-03S	5/32"	NPT 1/4	17.5	10.4	18.5	12.9	18.3	34.2	25.6	42.5	39.9	34.9	34.4	29.4	16	32	
AS23□1FM-N02-05S	3/16"			11.4				31.1	23.9	41.6					17		17
AS23□1FM-N02-07S	1/4"			13.2				34.2	25.6	42.5					18.5		39
AS23□1FM-N02-09S	5/16"	15.2	15.2	35.2	28.2	45.1	18.5	39									
AS23□1FM-N02-11S	3/8"	17.9	20.2	38.7	31	47.9	21	40									

Note 1) Reference dimensions

Note 2) Reference dimensions of 10-32 UNF and NPT threads after installation.

Speed Controller for Low Speed Operation with One-touch Fitting In-line Type

AS-FM Series



Model

Model	Applicable tubing O.D.								
	Metric size				Inch size				
	3.2	4	6	8	1/8"	5/32"	3/16"	1/4"	5/16"
AS1001FM	●	●	●		●	●	●	●	
AS2001FM		●	●			●	●	●	
AS2051FM			●	●			●	●	●

Specifications

Fluid	Air
Proof pressure	1.5 MPa
Max. operating pressure	1 MPa
Min. operating pressure	0.1 MPa
Ambient and fluid temperature	-5 to 60°C (No freezing)
Applicable tubing material ⁽¹⁾	Nylon, Soft nylon, Polyurethane

Note 1) Use caution regarding the max. operating pressure when soft nylon or polyurethane tubing is used.

(Refer to pages 678 and 682 for details.)

Note 2) Brass parts are all electroless nickel plated. The handle of the M5 type is black zinc chromate plated.

Flow Rate and Sonic Conductance

Flow Direction Symbols on Body



Model	AS1001FM	AS2001FM	AS2051FM			
Tubing O.D.	Metric size	ø3.2, ø4, ø6	ø4	ø6	ø6	ø8
	Inch size	ø1/8", ø5/32", ø3/16", ø1/4"	ø5/32"	ø3/16", ø1/4"	ø3/16"	ø1/4", ø5/16"
Controlled flow	Flow rate (L/min (ANR))	7	12		38	
	Sonic conductance dm ³ /(s bar)	0.02	0.04		0.12	
	Critical pressure ratio	0.2	0.2		0.2	
Free flow	Flow rate (L/min (ANR))	100	130	230	290	460
	Sonic conductance dm ³ /(s bar)	0.3	0.4	0.7	0.9	1.4
	Critical pressure ratio	0.25				

Note) Flow rate values are measured at 0.5 MPa and 20°C.

Caution

Be sure to read this before handling the products. Refer to page 11 for safety instructions and pages 19 to 22 for flow control equipment precautions.

Made to Order
(Refer to page 950 for details.)

How to Order

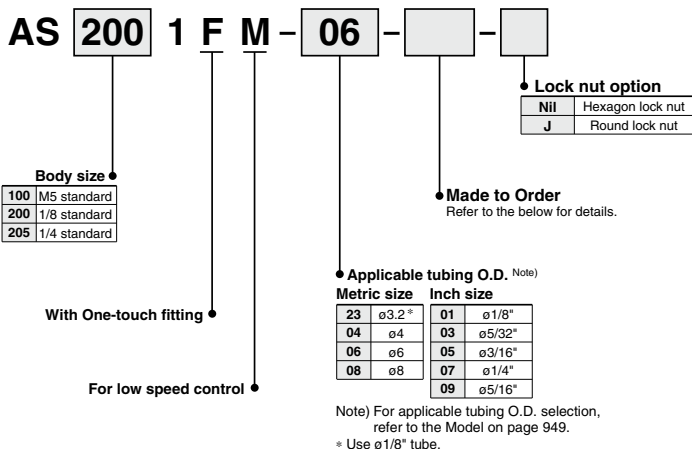

Made to Order



Lubricant: Vaseline

X12

Ex.) AS2001FM-04-X12

Grease-free (Seal: Fluorine Coated) + Throttle Valve (Without Check Valve)

X21

Ex.) AS2001FM-04-X21

Note 1) Not particle-free

Throttle Valve (Without Check Valve)

X214

Ex.) AS2001FM-04-X214

Needle Valve/Flow Rate Characteristics

Note) The flow rate characteristics are representative values.

AS1001FM

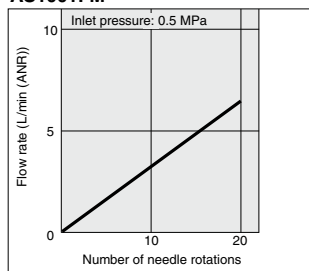

AS2001FM

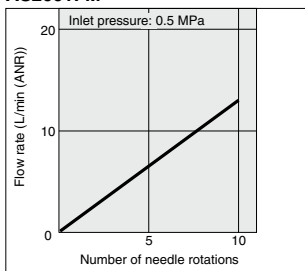

AS2051FM

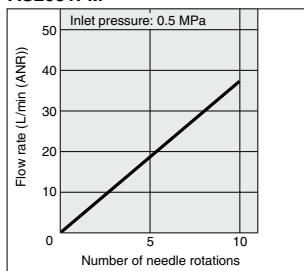

Construction

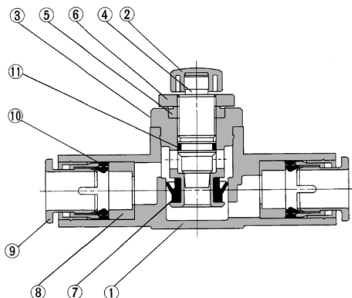

Component Parts

No.	Description	Material	Note
1	Body A	PBT	
2	Handle	PBT (1)	Black
3	Body B	Brass	Electroless nickel plated
4	Needle	Brass	Electroless nickel plated
5	Needle guide	Brass	Electroless nickel plated
6	Lock nut	Steel (3)	Zinc chromated (2)
7	U seal	HNBR	
8	Spacer	—	
9	Cassette	—	
10	Seal	NBR	
11	O-ring	NBR	

Note 1) AS1001FM type is made of brass (black zinc chromate plated).

Note 2) The round lock nut is electroless nickel plated.

Note 3) For round lock nut, only the AS1001FM uses brass.

Dimensions

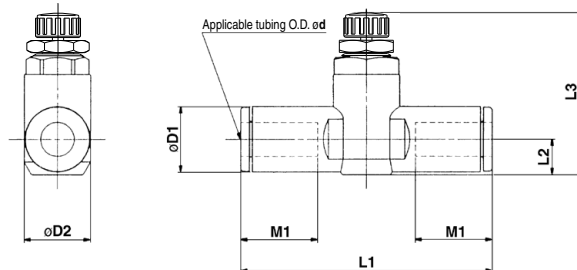

Metric Size

Model	d	D1	D2	L1	L2	L3		M1	Weight (g)
						Max.	Min.		
AS1001FM-23	3.2	8.4	10.5	38	4.5	30.1	24.9	12.7	6
AS1001FM-04	4	9.3		39.2	5.2	30.7	25.5	7	7
AS1001FM-06	6	11.6	12.3	40.7	6.2	31.8	26.6	13.7	8
AS2001FM-04	4	9.3		40.7	5.2	32.6	27.6	12.7	12
AS2001FM-06	6	11.6	15.5	44.8	6.3	33.7	28.7	13.7	13
AS2051FM-06	6	12.8		53.2	6.7	35.2	30.2	17	26
AS2051FM-08	8	15.2		59.8	8.1	36.5	31.5	18	31

Inch Size

Model	d	D1	D2	L1	L2	L3 (1)		M1	Weight (g)
						Max.	Min.		
AS1001FM-01	1/8"	8.4	10.5	38	4.5	30.1	24.9	12.7	6
AS1001FM-03	5/32"	9.3		39.2	5.2	30.7	25.5	7	7
AS1001FM-05	3/16"	11.4	12.3	48.7	6.2	31.8	26.6	13.7	8
AS1001FM-07	1/4"	12		40.7	5.2	32.6	27.6	12.7	12
AS2001FM-03	5/32"	9.3	15.5	40.7	5.2	32.6	29.6	12.7	12
AS2001FM-05	3/16"	11.4		50	6.2	33.6	28.6	16.5	18
AS2001FM-07	1/4"	13.2		52.2	7.1	34.5	29.5	17	21
AS2051FM-05	3/16"	11.4	15.5	52.2	6.2	34.6	29.6	16.5	24
AS2051FM-07	1/4"	13.2		54.4	7.1	35.5	30.5	17	26
AS2051FM-09	5/16"	15.2		59.8	8.1	36.5	31.5	18	31

Note 1) Reference dimensions

Dual Speed Controller for Low Speed Operation with One-touch Fitting

ASD-FM Series



Two flow control valves and check valves integrated.

Prevention of a stick-slip phenomenon, and speed control of a single acting cylinder.

Stable speed control is achievable even with load fluctuations.

Low speed control for small bore cylinders.



Symbol

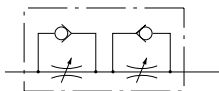

Flow Direction Symbols on Body

	Meter-out type	Meter-in type
Indication symbol		
Symbol		

Model

Model	Applicable tubing									
	Metric size				Inch size					
	4	6	8	10	1/8"	5/32"	3/16"	1/4"	5/16"	3/8"
ASD230FM-M5	●	●								
ASD330FM-01		●	●							
ASD430FM-02		●	●	●						
ASD230FM-U10/32					●	●	●			
ASD330FM-N01							●	●	●	
ASD430FM-N02								●	●	●

Specifications

Fluid	Air
Proof pressure	1.5 MPa
Max. operating pressure	1 MPa
Min. operating pressure	0.1 MPa
Ambient and fluid temperature	-5 to 60°C (No freezing)
Applicable tubing material ⁽¹⁾	Nylon, Soft nylon, Polyurethane

Note 1) Use caution regarding the max. operating pressure when soft nylon or polyurethane tubing is used.

(Refer to pages 678 to 682 for details.)

Note 2) Brass parts are all electroless nickel plated. The lock nut of the meter-out type is zinc chromate plated (the round lock nut is electroless nickel plated), then, the handle of the M5 type and the lock nut of the meter-in type are black zinc chromate plated.

Flow Rate and Sonic Conductance

Tubing O.D.	Model	ASD230FM	ASD330FM	ASD430FM	
	Metric size	ø4,ø6	ø6,ø8	ø6	ø8,ø10
	Inch size	ø1/8", ø5/32" ø3/16", ø1/4"	ø3/16", ø1/4"	—	ø1/4", ø5/16" ø3/8"
Controlled flow	Flow rate (L/min(ANR))	7	12	38	
	Sonic conductance dm ³ /(s·bar)	0.02	0.04	0.12	
	Critical pressure ratio	0.25	0.2	0.2	
Free flow	Flow rate (L/min(ANR))	7	12	38	
	Sonic conductance dm ³ /(s·bar)	0.02	0.04	0.12	
	Critical pressure ratio	0.3	0.15	0.15	

Note) Flow rate values are measured at 0.5 MPa and 20°C.

Made to Order
(Refer to page 953 for details.)

How to Order

ASD 3 3 0 F M - [] 01 - 06 S - [] - []

Body size

2	M5 standard
3	1/8 standard
4	1/4 standard

Universal

With One-touch fitting

For low speed control

Thread type

NII	Metric thread (M5)
	Unified thread (10-32 UNF)
N	R
	NPT

Lock nut option

NII	Hexagon lock nut.
J	Round lock nut

Made to Order
Refer to the below for details.

With seal
* M5 and U10/32 are not available with seal.

Applicable tubing O.D. (Note)

Metric size	Inch size
04	ø4
06	ø6
08	ø8
10	ø10

01	ø1/8"
03	ø5/32"
05	ø3/16"
07	ø1/4"
09	ø5/16"
11	ø3/8"

(Note) For applicable tubing O.D. selection, refer to the Model on page 952.

Port size

M5	M5 x 0.8
U10/32	10-32 UNF
01	1/8
02	1/4

Made to Order



Lubricant: Vaseline

X12

Ex.) ASD230FM-M5-X12

Needle Valve/Flow Rate Characteristics

(Note) The flow rate characteristics are representative values.

ASD230FM

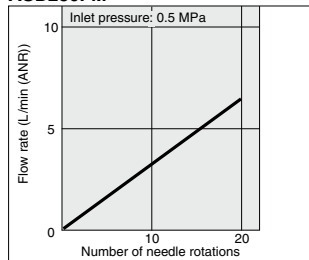

ASD330FM

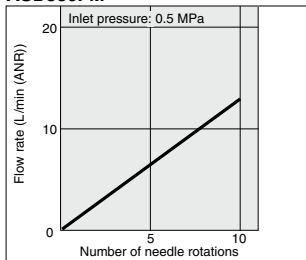

ASD430FM

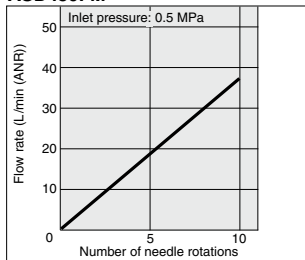

ASD-FM Series

Construction

ASD230FM

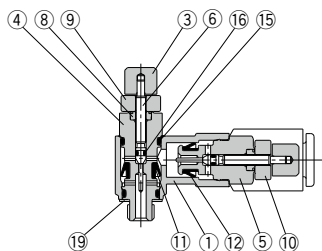
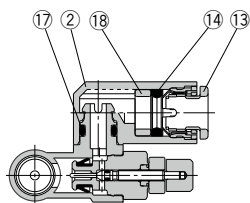

ASD330FM/430FM

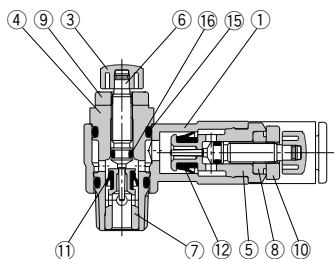
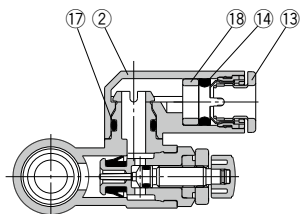

Component Parts

No.	Description	Material	Note
1	Body A	PBT	
2	Elbow body	PBT	
3	Handle	PBT ⁽¹⁾	Black
4	Body B	Brass	Electroless nickel plated
5	Body B	Brass	Electroless nickel plated
6	Needle	Brass	Electroless nickel plated
7	Seat ring	Brass	Electroless nickel plated
8	Needle guide	Brass	Electroless nickel plated
9	Lock nut	Steel ⁽²⁾	Zinc chromated ⁽³⁾
10	Lock nut	Steel ⁽²⁾	Black zinc chromated

Component Parts

No.	Description	Material	Note
11	U seal	HNBR	
12	U seal	HNBR	
13	Cassette	—	
14	Seal	NBR	
15	O-ring	NBR	
16	O-ring	NBR	
17	O-ring	NBR	
18	Spacer	—	
19	Gasket	NBR, Stainless steel	M5 type only

Note 1) ASD230FM type is made of brass (black zinc chromate plated).
 Note 2) The material of the lock nut option-J (round type) is brass. However, note that only the ASD330FM and ASD430FM use steel.

Note 3) The surface treatment of the lock nut option-J (round type) is electroless nickel plated.

Dual Speed Controller for Low Speed Operation with One-touch Fitting **ASD-FM Series**

Dimensions: Metric Size

ASD230FM

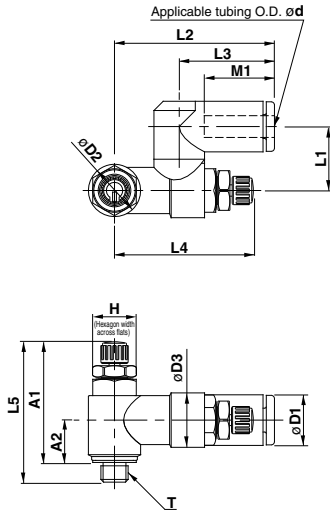

ASD330FM/430FM

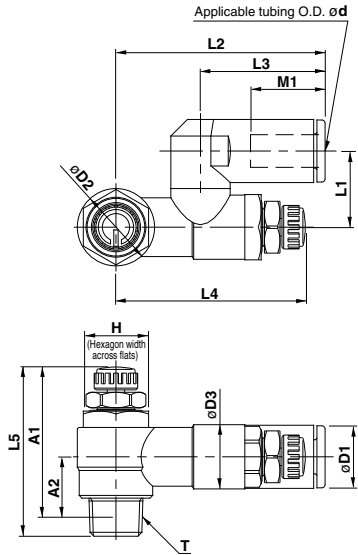

Metric Size

Model	d	T	H	D1	D2	D3	L1	L2	L3	L4		L5 ⁽¹⁾		A1 ⁽²⁾		A2 ⁽²⁾	M1	Weight (g)
										Max.	Min.	Max.	Min.	Max.	Min.			
ASD230FM-M5-04	4	M5 x 0.8	8	9.3	9.6	10	11.7	29.4	17.5	34.6	29.6	33.8	28.8	30.1	25.1	7.8	12.9	12
ASD230FM-M5-06	6			11.6				20.6	13.7								13	
ASD330FM-01-06S	6	R 1/8	12	11.6	14.2	11.8	14	38.5	22.9	39.6	34.6	35.2	30.2	32.1	27.1	10.6	13.7	29
ASD330FM-01-08S	8			15.2			28.2	38.9	33.9	18.5	31							
ASD430FM-02-06S	6	R 1/4	17	12.8	18.5	15	18	43.5	25.2	41.8	36.8	39.9	34.9	34.4	29.4	11	17	53
ASD430FM-02-08S	8			15.2			28.2	46.5	28.2								18.5	55
ASD430FM-02-10S	10			18.5			19.7	49.3	31							21	58	

Note 1) Reference dimensions

Note 2) Reference dimensions of M5 x 0.8, R threads after installation.

ASD-FM Series

Dimensions: Inch Size

ASD230FM

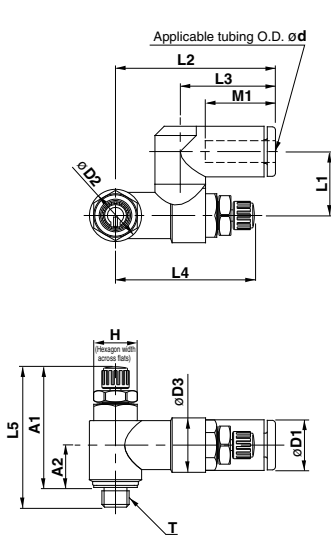

ASD330FM/430FM

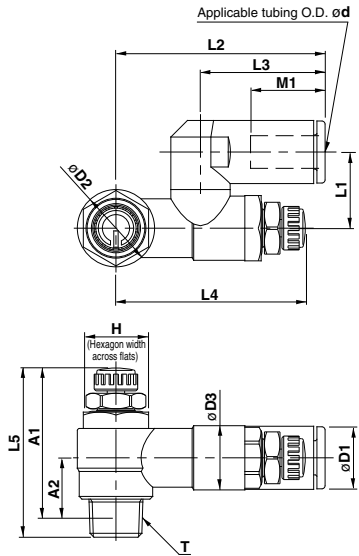

Inch Size

Model	d	T	H	D1	D2	D3	L1	L2	L3	L4		L5 ⁽¹⁾		A1 ⁽²⁾		A2 ⁽²⁾	M1	Weight (g)
										Max.	Min.	Max.	Min.	Max.	Min.			
ASD230FM-U10/32-01	1/8"	10-32 UNF	8	8.4	9.6	10	11.7	29.4	17.5	34.6	29.6	33.8	28.8	30.1	25.1	7.8	12.9	12
ASD230FM-U10/32-03	5/32"			9.3				23.3	13									
ASD230FM-U10/32-05	3/16"			11.4				20.7	14									
ASD330FM-U10/32-07	1/4"		12	32.6	20.7												13.5	15
ASD330FM-N01-05S	3/16"		11.4	14	39.5	23.9	39.6	34.6									16.5	30
ASD330FM-N01-07S	1/4"	NPT 1/8	12.7	13.2	14.2	11.8	15.8	42.2	25.6	38.9	33.9	35.2	30.2	32	27	10.6	17	31
ASD330FM-N01-09S	5/16"		15.2	44.8	28.2			43.9	25.6								18.5	
ASD430FM-N02-07S	1/4"		13.2	43.9	25.6			46.5	28.2	41.7	36.7	39.9	34.9	34.6	29.6	11	17	55
ASD430FM-N02-09S	5/16"	NPT 1/4	17.5	15.2	18.5	15	18	46.5	28.2	41.7	36.7	39.9	34.9	34.6	29.6	11	18.5	
ASD430FM-N02-11S	3/8"		18.5	49.3	32.6		19.7	49.3	32.6								21	62

Note 1) Reference dimensions

Note 2) Reference dimensions of 10-32UNF and NPT threads after installation.



ASD-FM Series Specific Product Precautions

Be sure to read this before handling the products. Refer to page 11 for safety instructions and pages 19 to 22 for flow control equipment precautions.

Design/Selection

⚠ Caution

1. Single acting cylinder

When controlling a single acting cylinder, the cylinder's return speed will differ depending on the operating conditions. Operate after confirming the maximum return speeds shown in the table below.

Speed Controller	Cylinder	Solenoid valve	Tubing	Silencer	Max. return speed (mm/s)		
					10	20	30
ASD230FM	CJ2	SYJ500	TU0604 1 m	AN110-01			
ASD330FM	CM2	SYJ700	TU0604 1 m	AN110-01			

* Values are measured at 0.5 MPa and 20°C.

<Operating conditions>

- Cylinder extension speed: 100 mm/s
- Meter-out needle fully open

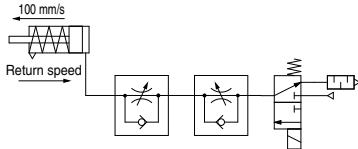

(Reference) Recommended circuit for high return speed

When low extension speed and high return speed are desired, the following circuit using 3-port is recommended.

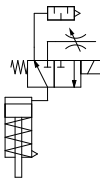

Note) Use AS-FM series with -X214 for the throttle valve.

Speed Controller for Low Speed Operation Standard Type (Metal Body)

AS-M Series

RoHS

Model/Specifications

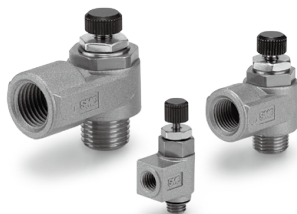

Symbol

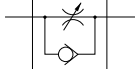

Model		AS12□0M		AS22□0M-□01		AS22□0M-□02	
Port size	Cylinder side	M5 x 0.8	10-32 UNF	R 1/8	NPT 1/8	R 1/4	NPT 1/4
	Tubing side			Rc 1/8		Rc 1/4	
Fluid		Air					
Proof pressure		1.5 MPa					
Max. operating pressure		1.0 MPa					
Min. operating pressure		0.1 MPa					
Ambient and fluid temperature		-5 to 60°C (No freezing)					
Option		Round lock nut		With seal, Round lock nut			
Weight (g)		11.5		36		74	
Controlled flow	Flow rate (L/min (ANR))	7		12		38	
	Sonic conductance dm ³ /(s·bar)	0.02		0.04		0.12	
	Critical pressure ratio	0.2		0.25		0.3	
Free flow	Flow rate (L/min (ANR))	105		280		420	
	Sonic conductance dm ³ /(s·bar)	0.32		0.86		1.3	
	Critical pressure ratio	0.4		0.2		0.3	

Note 1) Flow rate values are measured at 0.5 MPa and 20°C.

Note 2) Meter-out and meter-in types can be visually differentiated by the lock nut. Meter-out type is electroless nickel plated (the round lock nut is electroless nickel plated), while meter-in type is black zinc chromate plated.

Note 3) Brass parts are all electroless nickel plated. The handle is black zinc chromate plated.

How to Order

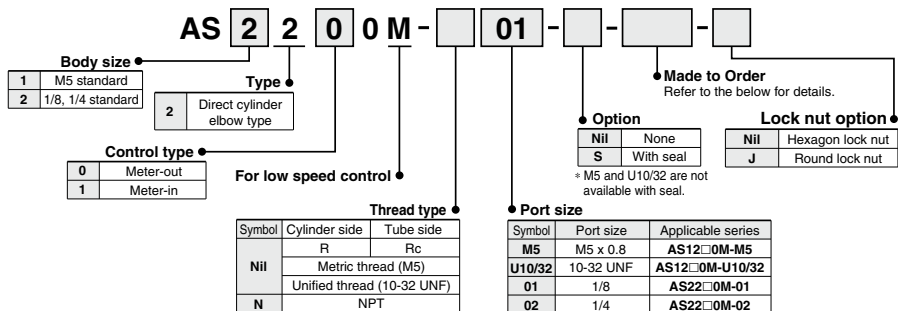

Made to Order

Made to Order

Lubricant: Vaseline

X12

Ex.) AS2200M-01-X12

Grease-free (Seal: Fluorine Coated) +
Throttle Valve (Without Check Valve)

X21

Ex.) AS2200M-01-X21

Note 1) Not particle-free

Note 2) Throttle valve is only compatible with the part no. of the meter-out type.

Throttle Valve (Without Check Valve) **X214**

Ex.) AS2200M-01-X214

Note) Throttle valve is only compatible with the part no. of the meter-out type.

Needle Valve/Flow Rate Characteristics

Note) The flow rate characteristics are representative values.

AS12□0M

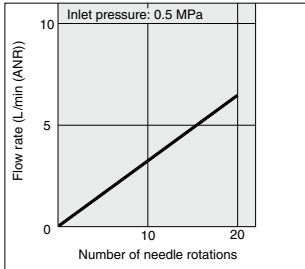

AS22□0M-□01

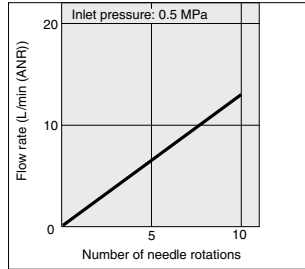

AS22□0M-□02

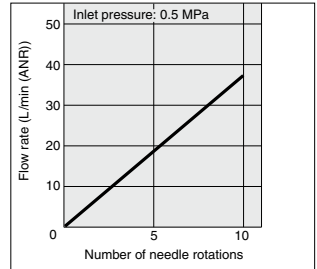

Construction

Meter-out type

AS1200M

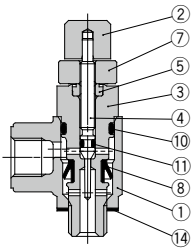

AS2200M

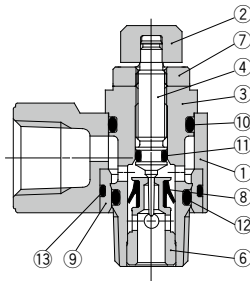

Meter-in type

AS1210M

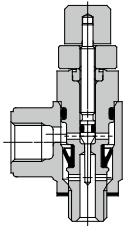

AS2210M

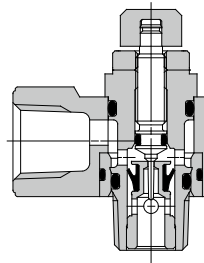

Component Parts

No.	Description	Material	Note
1	Body A	Zinc alloy	Chromate treated
2	Handle	Brass	Black zinc chromate plated
3	Body B	Brass	Electroless nickel plated
4	Needle	Brass	Electroless nickel plated
5	Needle guide	Brass	Electroless nickel plated
6	Seat ring	Brass	Electroless nickel plated
7	Lock nut	Steel ⁽¹⁾	Meter-out Zinc chromate plated ⁽²⁾ Meter-in Black zinc chromate plated
8	U seal	HNBR	
9	Bushing	PBT	
10	O-ring	NBR	
11	O-ring	NBR	
12	O-ring	NBR	
13	O-ring	NBR	
14	Gasket	NBR/Stainless steel	

Note 1) The material of the lock nut option-J (round type) is brass. However, note that only the AS22□0M uses steel.

Note 2) The surface treatment of the lock nut option-J (round type) is electroless nickel plated.

Caution

Be sure to read this before handling the products. Refer to page 11 for safety instructions and pages 19 to 22 for flow control equipment precautions.

AS-M Series

Dimensions

AS12□0M

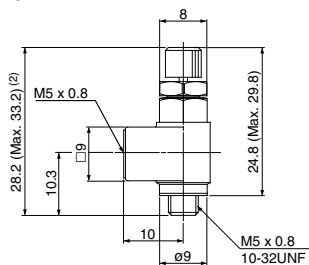

AS22□0M-□⁰¹₀₂

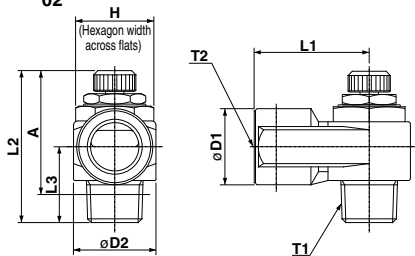

Dimensions

Model	T1	T2	H	L1	L2 (1)		L3	D1	D2	A (2)	
					Max.	Min.				Max.	Min.
AS12□0M-M5	M5 x 0.8		8	10	33.2	28.2	10.3	9	9	29.8	24.8
AS12□0M-U10/32	10-32 UNF										
AS22□0M-01	R 1/8	Rc 1/8	12	18	35.5	30.5	13.2	14.3	14.6	32.4	27.4
AS22□0M-N01	NPT 1/8		12.7								
AS22□0M-02	R 1/4	Rc 1/4	17	27.2	39.4	35.4	17.5	18	19.5	34.9	29.9
AS22□0M-N02	NPT 1/4		17.5								

Note 1) Reference dimensions

Note 2) Dimensions of R and NPT threads after installation.