

Model Switch type	55- C76	55- C85	55- C95	55- C96	55- CP96	55- C55	55- JCM	55- CG1	55- CS1	55- CQ2(Z)	55- CXS/W	55- MY1B	55- MY1M	55- MY1H	56- CRB1	56- CRB2	56- CRBU2	55- CRQ2
D-M9□-588	●	Note 1) ●		●	●	●	●	● (20 to 63)	● (125 to 200)	●		● (Except 50)	●	●				●
D-M9□V-588		Note 2) ●		●	●	●	●		● (125 to 200)	●		● (Except 50)	●	●				●
D-M9□W-588	●	Note 1) ●		●	●	●	●	● (20 to 63)	● (125 to 200)	●		● (Except 50)	●	●				●
D-M9□WV-588		Note 2) ●		●	●	●	●		● (125 to 200)	●		● (Except 50)	●	●				●
D-H7A2-588	●	Note 3) ●						● (20 to 63)										
D-F7P-588	●	Note 4) ●								● (12 to 160)								
D-F7PV-588	●	Note 4) ●								● (12 to 160)								
D-F5P-588			● (160 to 250)	●					● (125 to 200)									
D-Y7P-588			● (160 to 200)	●					● (125 to 200)		●	● (50 to 100)	● (25 to 63)					
D-Y7PV-588			● (160 to 200)	●					● (125 to 200)		●	● (50 to 100)	● (25 to 63)					
D-S7P-588															● (50 to 100)	● (20 to 40)	● (20 to 40)	
D-S9P-588																● (10, 15)	● (10, 15)	
D-S9PV-588																● (10, 15)	● (10, 15)	
D-C73-588 D-C80-588	●	Note 3) ●						● (20 to 63)										
D-A73-588 D-A80-588	●	Note 4) ●								● (12 to 160)								
D-A73H-588 D-A80H-588	●	Note 4) ●								● (12 to 160)								
D-A54-588 D-A67-588			● (160 to 250)	●					● (125 to 200)									
D-A90-588 D-A93-588	●	● (16 to 25)		●	●	●		● (20 to 63)	● (125 to 200)	●		● (10 to 40)	● (16, 20)	●				●
D-A90V-588 D-A93V-588		Note 5) ●		●	●	●			● (125 to 200)	●		● (10 to 40)	● (16, 20)	●				●
D-90A-588 D-93A-588									● (125 to 200)							● (10, 15)	● (10, 15)	
D-Z73-588 D-Z80-588			● (160 to 200)	●					● (125 to 200)		●	● (50 to 100)	● (25 to 63)					
D-R73-588 D-R80-588															● (50 to 100)	● (20 to 40)	● (20 to 40)	

* (): Cylinder size

Note 1) 55-C85 Band mounting all sizes, and Rail mounting for 8 to 16 only.

Note 2) 55-C85 Band mounting only.

Note 3) 55-C85 Rail mounting only.

Note 4) 55-C85 Rail mounting only.

Note 5) 55-C85 Rail mounting only, for 16 to 25 only.

ATEX Compliant

Solid State Switch/Direct Mounting

D-M9N(V)·D-M9P(V)·D-M9B(V)-588



II 3G Ex ec IIC T5 Gc -10°C ≤ Ta ≤ +60°C
II 3D Ex tc IIIC T93°C Dc IP67

Grommet

- 2-wire load current is reduced (2.5 to 40 mA).
- Using flexible cable as standard spec.



Auto Switch Specifications

PLC: Programmable Logic Controller

D-M9□/ D-M9□V (With indicator light)						
Auto switch part no.	D-M9N	D-M9NV	D-M9P	D-M9PV	D-M9B	D-M9BV
Electrical entry direction	In-line	Perpendicular	In-line	Perpendicular	In-line	Perpendicular
Wiring type	3-wire				2-wire	
Output type	NPN		PNP		—	
Applicable load	IC circuit, Relay, PLC				24 VDC relay, PLC	
Power supply	5/12/24 VDC (4.5 to 28 V)				—	
Current consumption	10 mA or less				—	
Load voltage	28 VDC or less		—		24 VDC (10 to 28V)	
Load current	40 mA or less				2.5 to 40 mA	
Internal voltage drop	0.8 V or less at 10 mA (2 V or less at 40 mA)				4 V or less	
Leakage current	100 μA or less at 24 VDC				0.8 mA or less	
Indicator light	Red LED illuminates when turned ON.					

Oilproof Flexible Heavy-duty Lead Wire Specifications

Auto switch model		D-M9N(V)	D-M9P(V)	D-M9B(V)
Sheath	Outside diameter [mm]	2.6		
Insulator	Number of cores	3 cores (Brown/Blue/Black)		2 cores (Brown/Blue)
	Outside diameter [mm]	0.88		
Conductor	Cross section [mm ²]	0.15		
	Strand diameter [mm]	0.05		
Minimum bending radius [mm] (Reference)		17		

Caution

Precautions

Fix the auto switch with the existing screw installed on the auto switch body. The auto switch may be damaged if a screw other than the one supplied is used.

How to Order

D - M9 N V L - 588

Auto switch part no. ●

Wiring and output ●

N	3-wire NPN
P	3-wire PNP
B	2-wire

Electrical entry direction ●

Nil	In-line
V	Perpendicular

Lead wire length ●

Nil	0.5 m
L	3 m
Z	5 m
SAPC	0.5 m + M8 - 3 pins pre-wired connector
MAPC	1 m + M8 - 3 pins pre-wired connector
SBPC	0.5 m + M8 - 4 pins pre-wired connector
MBPC	1 m + M8 - 4 pins pre-wired connector
SDPC	0.5 m + M12 - 4 pins pre-wired connector
MDPC	1 m + M12 - 4 pins pre-wired connector

● ATEX category 3

* This category 3 type auto switch can only be used in zones 2 and 22.

Connector Specifications

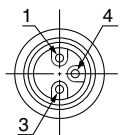
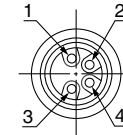
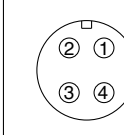
Connector type	M8 - 3 pins	M8 - 4 pins	M12 - 4 pins
Pin arrangement			

ATEX Compliant

2-Colour Solid State Switch/Direct Mounting D-M9NW(V)·D-M9PW(V)·D-M9BW(V)-588



II 3G Ex ec IIC T5 Gc -10°C ≤ Ta ≤ +60°C
II 3D Ex tc IIIC T93°C Dc IP67

Grommet

- 2-wire load current is reduced (2.5 to 40 mA).
- Using flexible cable as standard spec.



Caution

Precautions

Fix the auto switch with the existing screw installed on the auto switch body. The auto switch may be damaged if a screw other than the one supplied is used.

Auto Switch Specifications

PLC: Programmable Logic Controller

D-M9□W/D-M9□WV (With 2 colour indicator light)						
Auto switch part no.	D-M9NW	D-M9NWV	D-M9PW	D-M9PWV	D-M9BW	D-M9BWV
Electrical entry direction	In-line	Perpendicular	In-line	Perpendicular	In-line	Perpendicular
Wiring type	3-wire			2-wire		
Output type	NPN		PNP		—	
Applicable load	IC circuit, Relay, PLC				24 VDC relay, PLC	
Power supply	5/12/24 VDC (4.5 to 28 V)				—	
Current consumption	10 mA or less				—	
Load voltage	28 VDC or less		—		24 VDC (10 to 28V)	
Load current	40 mA or less				2.5 to 40 mA	
Internal voltage drop	0.8 V or less at 10 mA (2 V or less at 40 mA)				4 V or less	
Leakage current	100 μA or less at 24 VDC				0.8 mA or less	
Indicator light	Operating position Red LED illuminates. Optimum operating position Green LED illuminates.					

Oilproof Flexible Heavy-duty Lead Wire Specifications

Auto switch model		D-M9NW(V)	D-M9PW(V)	D-M9BW(V)
Sheath	Outside diameter [mm]	2.6		
Insulator	Number of cores	3 cores (Brown/Blue/Black)		2 cores (Brown/Blue)
	Outside diameter [mm]	0.88		
Conductor	Cross section [mm ²]	0.15		
	Strand diameter [mm]	0.05		
Minimum bending radius [mm] (Reference)		17		

How to Order

D - M9 N W V L - 588

Auto switch part no. ●

Wiring and output ●

N	3-wire NPN
P	3-wire PNP
B	2-wire

2 colour display ●

Electrical entry direction ●

Nil	In-line
V	Perpendicular

Lead wire length ●

Nil	0.5 m
M	1 m
L	3 m
Z	5 m
SAPC	0.5 m + M8 - 3 pins pre-wired connector
MAPC	1 m + M8 - 3 pins pre-wired connector
SBPC	0.5 m + M8 - 4 pins pre-wired connector
MBPC	1 m + M8 - 4 pins pre-wired connector
SDPC	0.5 m + M12 - 4 pins pre-wired connector
MDPC	1 m + M12 - 4 pins pre-wired connector

● ATEX category 3

* This category 3 type auto switch can only be used in zones 2 and 22.

Connector Specifications

Connector type	M8 - 3 pins	M8 - 4 pins	M12 - 4 pins
Pin arrangement			

ATEX Compliant

Solid State Switch/Band Mounting D-H7A2-588



II 3G Ex ec IIC T5 Gc -10°C ≤ Ta ≤ +60°C
II 3D Ex tc IIIC T93°C Dc IP67

Grommet



Auto Switch Specifications

PLC: Programmable Logic Controller

D-H7 A2 (With indicator light)	
Auto switch part no.	D-H7A2
Wiring type	3-wire
Output type	PNP
Applicable load	IC circuit/Relay/PLC
Power supply	5/12/24 VDC (4.5 to 28 VDC)
Current consumption	10 mA or less
Load current	80 mA or less
Internal voltage drop	0.8 V or less
Leakage current	100 μA or less at 24 VDC
Indicator light	Red LED illuminates when turned ON.

Oilproof Heavy-duty Lead Wire Specifications

Auto switch model		D-H7A2
Sheath	Outside diameter [mm]	ø3.4
Insulator	Number of cores	3 cores (Brown/Blue/Black)
	Outside diameter [mm]	ø1.1
Conductor	Cross section [mm ²]	0.2
	Strand diameter [mm]	ø0.08
Minimum bending radius [mm] (Reference)		21

How to Order

D - H7A2 **- 588**

Auto switch part no.

Lead wire length

• **ATEX category 3**

* This category 3 type auto switch can only be used in zones 2 and 22.

Nil	0.5 m
L	3 m
Z	5 m
SAPC	0.5 m + M8 - 3 pins pre-wired connector
MAPC	1 m + M8 - 3 pins pre-wired connector
SBPC	0.5 m + M8 - 4 pins pre-wired connector
MBPC	1 m + M8 - 4 pins pre-wired connector
SDPC	0.5 m + M12 - 4 pins pre-wired connector
MDPC	1 m + M12 - 4 pins pre-wired connector

Connector Specifications

Connector type	M8 - 3 pins	M8 - 4 pins	M12 - 4 pins
Pin arrangement			

ATEX Compliant

Solid State Switch/Rail Mounting D-F7P(V)-588



II 3G Ex ec IIC T5 Gc -10°C ≤ Ta ≤ +60°C
II 3D Ex tc IIIC T93°C Dc IP67

Auto Switch Specifications

PLC: Programmable Logic Controller

D-F7P, D-F7PV (With indicator light)		
Auto switch part no.	D-F7P	D-F7PV
Wiring type	3-wire	
Output type	PNP	
Applicable load	IC circuit/Relay/PLC	
Power supply	5/12/24 VDC (4.5 to 28 VDC)	
Current consumption	10 mA or less	
Load current	80 mA or less	
Internal voltage drop	0.8 V or less	
Leakage current	100 μA or less at 24 VDC	
Indicator light	Red LED illuminates when turned ON.	

Grommet



Oilproof Heavy-duty Lead Wire Specifications

Auto switch model		D-F7P(V)
Sheath	Outside diameter [mm]	ø3.4
Insulator	Number of cores	3 cores (Brown/Blue/Black)
	Outside diameter [mm]	ø1.1
Conductor	Cross section [mm ²]	0.2
	Strand diameter [mm]	ø0.08
Minimum bending radius [mm] (Reference)		21

How to Order

D-F7P **-588**

Auto switch part no.

Electrical entry direction

Nil	In-line
V	Perpendicular

Lead wire length

Nil	0.5 m
L	3 m
Z	5 m
SAPC	0.5 m + M8 - 3 pins pre-wired connector
MAPC	1 m + M8 - 3 pins pre-wired connector
SBPC	0.5 m + M8 - 4 pins pre-wired connector
MBPC	1 m + M8 - 4 pins pre-wired connector
SDPC	0.5 m + M12 - 4 pins pre-wired connector
MDPC	1 m + M12 - 4 pins pre-wired connector

ATEX category 3

* This category 3 type auto switch can only be used in zones 2 and 22.

Connector Specifications

Connector type	M8 - 3 pins	M8 - 4 pins	M12 - 4 pins
Pin arrangement			

ATEX Compliant

Solid State Switch/Tie-rod Mounting D-F5P-588



II 3G Ex ec IIC T5 Gc -10°C ≤ Ta ≤ +60°C
II 3D Ex tc IIIC T93°C Dc IP67

Grommet



Auto Switch Specifications

PLC: Programmable Logic Controller

D-F5P (With indicator light)	
Auto switch part no.	D-F5P
Wiring type	3-wire
Output type	PNP
Applicable load	IC circuit/Relay/PLC
Power supply	5/12/24 VDC (4.5 to 28 VDC)
Current consumption	10 mA or less
Load current	80 mA or less
Internal voltage drop	0.8 V or less
Leakage current	100 μA or less at 24 VDC
Indicator light	Red LED illuminates when turned ON.

Oilproof Heavy-duty Lead Wire Specifications

Auto switch model		D-F5P
Sheath	Outside diameter [mm]	ø4
Insulator	Number of cores	3 cores (Brown/Blue/Black)
	Outside diameter [mm]	ø1.22
Conductor	Cross section [mm ²]	0.3
	Strand diameter [mm]	ø0.08
Minimum bending radius [mm] (Reference)		24

How to Order

D - F5P **- 588**

Auto switch part no.

Lead wire length

ATEX category 3

* This category 3 type auto switch can only be used in zones 2 and 22.

Nil	0.5 m
L	3 m
Z	5 m
SAPC	0.5 m + M8 - 3 pins pre-wired connector
MAPC	1 m + M8 - 3 pins pre-wired connector
SBPC	0.5 m + M8 - 4 pins pre-wired connector
MBPC	1 m + M8 - 4 pins pre-wired connector
SDPC	0.5 m + M12 - 4 pins pre-wired connector
MDPC	1 m + M12 - 4 pins pre-wired connector

Connector Specifications

Connector type	M8 - 3 pins	M8 - 4 pins	M12 - 4 pins
Pin arrangement			

ATEX Compliant

Solid State Switch/Direct Mounting D-Y7P(V)-588



II 3G Ex ec IIC T5 Gc -10°C ≤ Ta ≤ +60°C
II 3D Ex tc IIIC T93°C Dc IP67

Auto Switch Specifications

PLC: Programmable Logic Controller

D-Y7P/D-Y7PV (With indicator light)		
Auto switch part no.	D-Y7P	D-Y7PV
Electrical entry direction	In-line	Perpendicular
Wiring type	3-wire	
Output type	PNP	
Applicable load	IC circuit/Relay/PLC	
Power supply	5/12/24 VDC (4.5 to 28 VDC)	
Current consumption	10 mA or less	
Load current	80 mA or less	
Internal voltage drop	0.8 V or less	
Leakage current	100 µA or less at 24 VDC	
Indicator light	Red LED illuminates when turned ON.	

Grommet



Oilproof Flexible Heavy-duty Lead Wire Specifications

Auto switch model		D-Y7P(V)
Sheath	Outside diameter [mm]	ø3.4
Insulator	Number of cores	3 cores (Brown/Blue/Black)
	Outside diameter [mm]	ø1.0
Conductor	Cross section [mm ²]	0.15
	Strand diameter [mm]	ø0.05
Minimum bending radius [mm] (Reference)		21

How to Order

D - Y7P **- 588**

Auto switch part no.

Electrical entry direction

Nil	In-line
V	Perpendicular

Lead wire length

Nil	0.5 m
L	3 m
Z	5 m
SAPC	0.5 m + M8 - 3 pins pre-wired connector
MAPC	1 m + M8 - 3 pins pre-wired connector
SBPC	0.5 m + M8 - 4 pins pre-wired connector
MBPC	1 m + M8 - 4 pins pre-wired connector
SDPC	0.5 m + M12 - 4 pins pre-wired connector
MDPC	1 m + M12 - 4 pins pre-wired connector

• ATEX category 3

* This category 3 type auto switch can only be used in zones 2 and 22.

Connector Specifications

Connector type	M8 - 3 pins	M8 - 4 pins	M12 - 4 pins
Pin arrangement			

ATEX Compliant

Solid State Switch/Direct Mounting D-S7P-588



II 3G Ex ec IIC T5 Gc -10°C ≤ Ta ≤ +60°C
II 3D Ex tc IIIC T93°C Dc IP67

**Grommet/Connector
Electrical entry: In-line**



Auto Switch Specifications

PLC: Programmable Logic Controller

D-S7P1/D-S7P2 (With indicator light)		
Auto switch part no.	D-S7P1	D-S7P2
Wiring type	3-wire	
Output type	PNP	
Applicable load	IC circuit/Relay/PLC	
Power supply	5/12/24 VDC (4.5 to 28 VDC)	
Current consumption	10 mA or less	
Load current	40 mA or less	
Internal voltage drop	0.8 V or less at 10 mA (2 V or less at 40 mA)	
Leakage current	100 μA or less at 24 VDC	
Indicator light	Red LED illuminates when turned ON.	

Oilproof Heavy-duty Lead Wire Specifications

Auto switch model		D-S7P(V)
Sheath	Outside diameter [mm]	ø3.4
Insulator	Number of cores	3 cores (Brown/Blue/Black)
	Outside diameter [mm]	ø1.1
Conductor	Cross section [mm ²]	0.2
	Strand diameter [mm]	ø0.08
Minimum bending radius [mm] (Reference)		21

D-S7P2

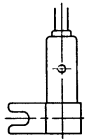

Left hand mounting

D-S7P1

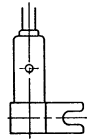

Right hand mounting

How to Order

D - S7P **- 588**

Auto switch part no.

Mounting

1	Right hand mounting
2	Left hand mounting

Lead wire length

Nil	0.5 m
L	3 m
Z	5 m
SAPC	0.5 m + M8 - 3 pins pre-wired connector
MAPC	1 m + M8 - 3 pins pre-wired connector
SBPC	0.5 m + M8 - 4 pins pre-wired connector
MBPC	1 m + M8 - 4 pins pre-wired connector
SDPC	0.5 m + M12 - 4 pins pre-wired connector
MDPC	1 m + M12 - 4 pins pre-wired connector

ATEX category 3

* This category 3 type auto switch can only be used in zones 2 and 22.

Connector Specifications

Connector type	M8 - 3 pins	M8 - 4 pins	M12 - 4 pins
Pin arrangement			

ATEX Compliant

Solid State Switch/Direct Mounting D-S9P(V)-588



II 3G Ex ec IIC T5 Gc -10°C ≤ Ta ≤ +60°C
II 3D Ex tc IIIC T93°C Dc IP67

Auto Switch Specifications

PLC: Programmable Logic Controller

D-S9P/D-S9PV (With indicator light)		
Auto switch part no.	D-S9P1 D-S9P2	D-S9PV1 D-S9PV2
Electrical entry direction	In-line	Perpendicular
Wiring type	3-wire	
Output type	PNP	
Applicable load	IC circuit/Relay/PLC	
Power supply	5/12/24 VDC (4.5 to 28 VDC)	
Current consumption	10 mA or less	
Load current	40 mA or less	
Internal voltage drop	0.8 V or less at 10 mA (2 V or less at 40 mA)	
Leakage current	100 μA or less at 24 VDC	
Indicator light	Red LED illuminates when turned ON.	

Grommet



Oilproof Heavy-duty Lead Wire Specifications

Auto switch model		D-S9P(V)
Sheath	Outside diameter [mm]	ø3.4
Insulator	Number of cores	3 cores (Brown/Blue/Black)
	Outside diameter [mm]	ø1.1
Conductor	Cross section [mm ²]	0.2
	Strand diameter [mm]	ø0.08
Minimum bending radius [mm] (Reference)		21

D-S9P1

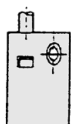

Left hand mounting

D-S9P2

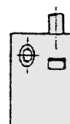

Right hand mounting

D-S9PV1

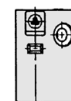

Left hand mounting

D-S9PV2

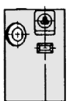

Right hand mounting

How to Order

D-S9P [] [] [] - 588

Auto switch part no. •

Electrical entry direction •

Nil	In-line
V	Perpendicular

Mounting •

1	Right hand mounting
2	Left hand mounting

Lead wire length •

Nil	0.5 m
L	3 m
Z	5 m
SAPC	0.5 m + M8 - 3 pins pre-wired connector
MAPC	1 m + M8 - 3 pins pre-wired connector
SBPC	0.5 m + M8 - 4 pins pre-wired connector
MBPC	1 m + M8 - 4 pins pre-wired connector
SDPC	0.5 m + M12 - 4 pins pre-wired connector
MDPC	1 m + M12 - 4 pins pre-wired connector

• ATEX category 3

* This category 3 type auto switch can only be used in zones 2 and 22.

Connector Specifications

Connector type	M8 - 3 pins	M8 - 4 pins	M12 - 4 pins
Pin arrangement			

Prior to Use

Auto Switch/Internal Circuit

Reed Auto Switch

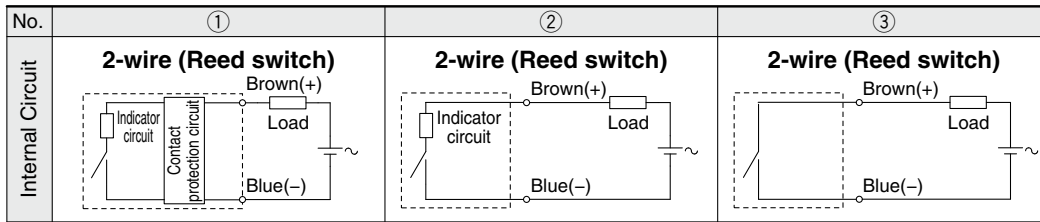

Contact Protection Box: CD-P12

<Applicable switch models>

D-A73/A8, D-A73H/A80H, D-C73/C8, D-E73A/E80A, D-Z73/Z8, 9□A, and D-A9/A9□V type

The auto switches above do not have a built-in contact protection circuit.

A contact protection box is not required for solid state auto switches due to their construction.

- ① Where the operation load is an inductive load.
 - ② Where the wiring length to load is greater than 5 m.
- Therefore, use a contact protection box with the switch for any of the above cases:

The contact life may be shortened (due to permanent energizing conditions.)

Even for the built-in contact protection circuit type (D-A54), use the contact protection box when the wiring length to load is very long (over 30 m) and PLC (Programmable Logic Controller) with a large inrush current is used.

Contact Protection Box Specifications

Part no.	CD-P12
Load voltage	24 VDC
Max. load current	50 mA



* Lead wire length — Auto switch connection side 0.5 m
Load connection side 0.5 m

Contact Protection Box Internal Circuit

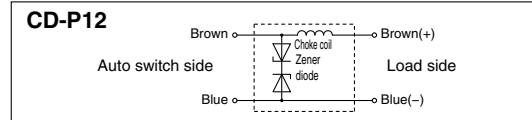

Contact Protection Box/Dimensions

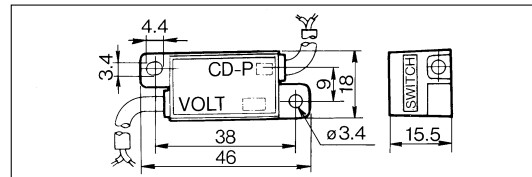

Contact Protection Box Connection

To connect a switch unit to a contact protection box, connect the lead wire from the side of the contact protection box marked SWITCH to the lead wire coming out of the switch unit. Keep the switch as close as possible to the contact protection box, with a lead wire length of no more than 1 meter.

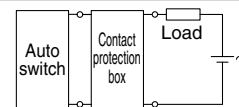

ATEX Compliant

Reed Switch/Band Mounting D-C73/D-C80-588



II 3G Ex ec IIC T5 Gc -10°C ≤ Ta ≤ +60°C
II 3D Ex tc IIIC T93°C Dc IP67

Grommet



Auto Switch Specifications

PLC: Programmable Logic Controller

D-C7 (With indicator light)		
Auto switch model number	D-C73	
Applicable load	Relay/PLC	
Load voltage	24 VDC	
Max. load current and range	5 to 40 mA	
Internal circuit *1	②	
Contact protection circuit	None	
Internal voltage drop	2.4 V or less	
Indicator light	Red LED illuminates when turned ON	
Standards	CE marking	
D-C8 (Without indicator light)		
Auto switch model number	D-C80	
Applicable load	Relay/PLC/IC circuit	
Load voltage	24 V _{DC} ^{AC} or less	48 V _{DC} ^{AC}
Max. load current	50 mA	40 mA
Internal circuit *1	③	
Contact protection circuit	None	
Internal resistance	1 Ω or less (Including 3 m lead wire)	

*1 Refer to the applicable internal circuit diagram (numbers ① to ③) on page 79.

Oilproof Heavy-duty Lead Wire Specifications

Auto switch type		D-C73/D-C80
Sheath	Outside diameter [mm]	ø3.4
	Number of cores	2 cores (Brown, Blue)
Insulator	Outside diameter [mm]	ø1.1
	Cross section [mm ²]	0.2
Conductor [mm]	Strand diameter [mm]	ø0.08
	Minimum bending radius of lead wire [mm] (Reference)	21

How to Order

D - C **- 588**

Auto switch model number

73	With indicator light
80	Without indicator light

• **ATEX category 3**

* This category 3 type auto switch can only be used in zones 2 and 22.

• **Lead wire length**

Nil	0.5 m
L	3 m
Z	5 m (Except D-C80)

ATEX Compliant

Reed Switch/Rail Mounting D-A73(H)/D-A80(H)-588



II 3G Ex ec IIC T5 Gc -10°C ≤ Ta ≤ +60°C
II 3D Ex tc IIIC T93°C Dc IP67

**Grommet
Electrical entry: Perpendicular**



Auto Switch Specifications

PLC: Programmable Logic Controller

D-A73, D-A73H (With indicator light)		
Auto switch model number	D-A73/D-A73H	
Applicable load	Relay/PLC	
Load voltage	24 VDC	
Load current range	5 to 40 mA	
Internal circuit *1	②	
Contact protection circuit	None	
Internal voltage drop	2.4 V or less	
Indicator light	Red LED illuminates when turned ON	
Standard	CE marking	
D-A80, D-A80H (Without indicator light)		
Auto switch model number	D-A80/D-A80H	
Applicable load	Relay/IC circuit/PLC	
Load voltage	24 V ^{AC} _{DC} or less	48 V ^{AC} _{DC}
Max. load current	50 mA	40 mA
Internal circuit *1	③	
Contact protection circuit	None	
Internal resistance	1 Ω or less (Including 3 m lead wire)	

*1 Refer to the applicable internal circuit diagram (numbers ① to ③) on page 79.

Oilproof Heavy-duty Lead Wire Specifications

Auto switch type		D-A73/D-A73H/D-A80/D-A80H
Sheath	Outside diameter [mm]	φ3.4
	Number of cores	2 cores (Brown, Blue)
Insulator	Outside diameter [mm]	φ1.1
	Cross section [mm ²]	0.2
Conductor	Strand diameter [mm]	φ0.08
	Minimum bending radius of lead wire [mm] (Reference)	21

How to Order

D - A **- 588**

- **Auto switch model number**

73	With indicator light
80	Without indicator light
- **Electrical Entry**

Nil	Perpendicular
H	In-line
- **Lead wire length**

Nil	0.5 m
L	3 m
Z	5 m (Except A 80□)
- **ATEX category 3**
* This category 3 type auto switch can only be used in zones 2 and 22.

ATEX Compliant

Reed Switch/Tie-rod Mounting D-A54/D-A67-588



II 3G Ex ec IIC T5 Gc -10°C ≤ Ta ≤ +60°C
II 3D Ex tc IIIC T93°C Dc IP67

Auto Switch Specifications

PLC: Programmable Logic Controller

Grommet



D-A54 (With indicator light)	
Auto switch model number	D-A54
Applicable load	Relay/PLC
Load voltage	24 VDC
Max. load current and range	5 to 50 mA
Internal circuit *1	①
Contact protection circuit	Built-in
Internal voltage drop	2.4 V or less (up to 20 mA) / 3.5 V or less (up to 50 mA)
Indicator light	Red LED illuminates when turned ON
Standard	CE marking
D-A67 (Without indicator light)	
Auto switch model number	D-A67
Applicable load	PLC/IC circuit
Load voltage	MAX. 24 VDC
Max. load current and range	30 mA
Internal circuit *1	③
Contact protection circuit	None
Internal resistance	1 Ω or less (Including 3 m lead wire)

*1 Refer to the applicable internal circuit diagram (numbers ① to ③) on page 79.

Oilproof Heavy-duty Lead Wire Specifications

Auto switch type		D-A54/D-A67
Sheath	Outside diameter [mm]	ø4
	Number of cores	2 cores (Brown, Blue)
Insulator	Outside diameter [mm]	ø1.22
	Cross section [mm ²]	0.3
Conductor	Strand diameter [mm]	ø0.08
	Minimum bending radius of lead wire [mm] (Reference)	24

How to Order

D - A - 588

Auto switch model number

54	With indicator light
67	Without indicator light

• ATEX category 3

* This category 3 type auto switch can only be used in zones 2 and 22.

• Lead wire length

Nil	0.5 m
L	3 m
Z	5 m (Except D-A67)

ATEX Compliant

Reed Switch/Direct Mounting D-A90(V)/D-A93(V)-588



II 3G Ex ec IIC T5 Gc -10°C ≤ Ta ≤ +60°C
II 3D Ex tc IIIC T93°C Dc IP67

Auto Switch Specifications

PLC: Programmable Logic Controller

D-A90, D-A90V (Without indicator light)	
Auto switch model number	D-A90/D-A90V
Applicable load	IC circuit/Relay/PLC
Load voltage	24 V ^{AC} _{DC} or less
Max. load current	50 mA
Internal circuit *1	③
Contact protection circuit	None
Internal resistance	1 Ω or less (Including 3 m lead wire)
Standard	CE marking
D-A93, D-A93V (With indicator light)	
Auto switch model number	D-A93/D-A93V
Applicable load	Relay/PLC
Load voltage	24 VDC
Max. load current and load current range	5 to 40 mA
Internal circuit *1	②
Contact protection circuit	None
Internal voltage drop	D-A 93 — 2.4 V or less (up to 20 mA)/3 V or less (up to 40 mA) D-A 93V — 2.7 V or less
Indicator light	Red LED illuminates when turned ON

*1 Refer to the applicable internal circuit diagram (numbers ① to ③) on page 79.

Grommet



Oilproof Heavy-duty Lead Wire Specifications

Auto switch type		D-A90 (V)/D-A93 (V)
Sheath	Outside diameter [mm]	ø2.7
	Number of cores	2 cores (Brown, Blue)
Insulator	Outside diameter [mm]	ø0.96
	Cross section [mm ²]	0.18
Conductor	Strand diameter [mm]	ø0.08
	Minimum bending radius of lead wire [mm] (Reference)	17

How to Order

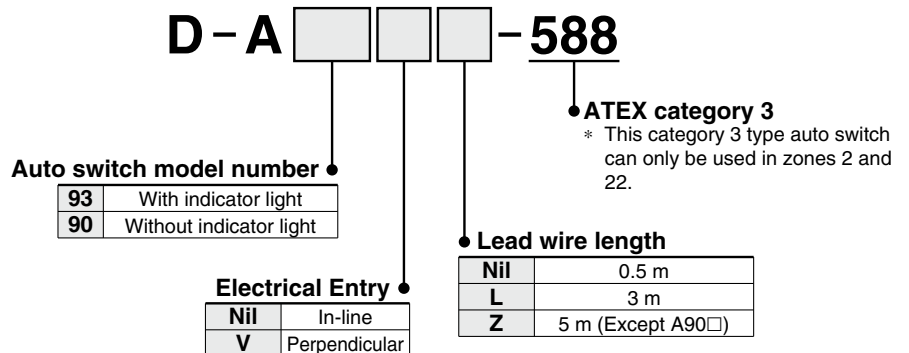

ATEX Compliant

Reed Switch/Direct Mounting D-90A/D-93A-588



II 3G Ex ec IIC T5 Gc -10°C ≤ Ta ≤ +60°C
II 3D Ex tc IIIC T93°C Dc IP67

Grommet
Lead wire: Heavy-duty cord

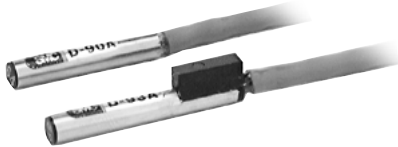

Auto Switch Specifications

PLC: Programmable Logic Controller

D-90A (Without indicator light)	
Auto switch model number	D-90A
Applicable load	Relay/IC circuit/PLC
Load voltage	24 V ^{AC} DC
Max. load current	50 mA
Internal circuit *1	③
Internal resistance	1 Ω or less (Including 3 m lead wire)
Standard	CE marking
D-93A (With indicator light)	
Auto switch model number	D-93A
Applicable load	Relay/PLC
Load voltage	24 VDC
Load current range	5 to 40 mA
Internal circuit *1	②
Internal voltage drop	2.4V or less
Indicator light	Red LED illuminates when turned ON

*1 Refer to the applicable internal circuit diagram (numbers ① to ③) on page 79.

Oilproof Heavy-duty Lead Wire Specifications

Auto switch type		D-90A/D-93A
Sheath	Outside diameter [mm]	ø3.4
Insulator	Number of cores	2 cores (Brown, Blue)
	Outside diameter [mm]	ø1.1
Conductor	Cross section [mm ²]	0.2
	Strand diameter [mm]	ø0.08
Minimum bending radius of lead wire [mm] (Reference)		21

How to Order

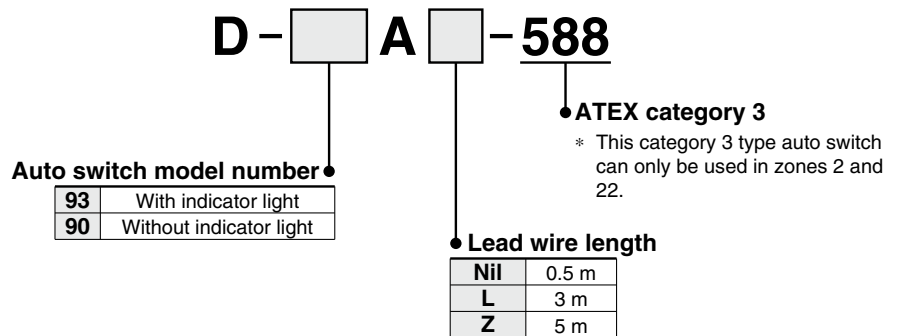

ATEX Compliant

Reed Switch/Direct Mounting D-Z73/D-Z80-588



II 3G Ex ec IIC T5 Gc -10°C ≤ Ta ≤ +60°C
II 3D Ex tc IIIC T93°C Dc IP67

Grommet

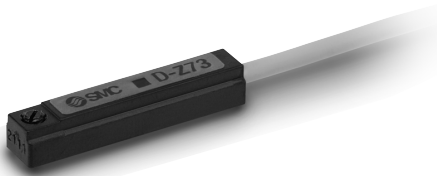

Auto Switch Specifications

PLC: Programmable Logic Controller

D-Z73 (With indicator light)		
Auto switch model number	D-Z73	
Applicable load	Relay/PLC	
Load voltage	24 VDC	
Max. load current and range	5 to 40 mA	
Internal circuit *1	②	
Contact protection circuit	None	
Internal voltage drop	2.4 V or less (up to 20 mA)/3 V or less (up to 40 mA)	
Indicator light	Red LED illuminates when turned ON	
Standard	CE marking	
D-Z80 (Without indicator light)		
Auto switch model number	D-Z80	
Applicable load	Relay/PLC/IC circuit	
Load voltage	24 V ^{AC} _{DC} or less	48 V ^{AC} _{DC}
Max. load current	50 mA	40 mA
Internal circuit *1	③	
Contact protection circuit	None	
Internal resistance	1 Ω or less (Including 3 m lead wire)	

*1 Refer to the applicable internal circuit diagram (numbers ① to ③) on page 79.

Oilproof Heavy-duty Lead Wire Specifications

Auto switch type		D-Z73/D-Z80
Sheath	Outside diameter [mm]	φ2.7
	Number of cores	2 cores (Brown, Blue)
Insulator	Outside diameter [mm]	φ1.1
	Cross section [mm ²]	0.18
Conductor	Strand diameter [mm]	φ0.08
	Minimum bending radius of lead wire [mm] (Reference)	17

How to Order

D - Z - 588

Auto switch model number

73	With indicator light
80	Without indicator light

• **ATEX category 3**

* This category 3 type auto switch can only be used in zones 2 and 22.

• **Lead wire length**

Nil	0.5 m
L	3 m
Z	5 m (Except D-Z80)

ATEX Compliant

Reed Switch/Direct Mounting D-R73/D-R80-588



II 3G Ex ec IIC T5 Gc -10°C ≤ Ta ≤ +60°C
II 3D Ex tc IIIC T93°C Dc IP67

**Grommet
Electrical entry: In-line**

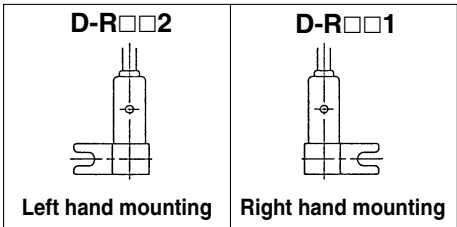

Auto Switch Specifications

PLC: Programmable Logic Controller

D-R73□ (With indicator light)	
Auto switch model number	D-R731/D-R732
Applicable load	Relay/PLC
Load voltage	24 VDC
Load current range	5 to 40 mA
Internal circuit *1	②
Internal voltage drop	2.4 V or less
Indicator light	Red LED illuminates when turned ON
Standard	CE marking
D-R80□ (Without indicator light)	
Auto switch model number	D-R801/D-R802
Applicable load	Relay/IC circuit/PLC
Load voltage	24 V ^{AC} / _{DC}
Max. load current	50 mA
Internal circuit *1	③
Internal resistance	1 Ω or less (Including 3 m lead wire)

*1 Refer to the applicable internal circuit diagram (numbers ① to ③) on page 79.

Oilproof Heavy-duty Lead Wire Specifications

Auto switch type		D-R73□/D-R80□
Sheath	Outside diameter [mm]	ø3.4
	Number of cores	2 cores (Brown, Blue)
Insulator	Outside diameter [mm]	ø1.1
	Cross section [mm ²]	0.2
Conductor	Strand diameter [mm]	ø0.08
	Minimum bending radius of lead wire [mm] (Reference)	21

How to Order

