



ORIGINAL INSTRUCTIONS

Instruction Manual Digital Flow Monitor LFE0 series



The intended use of the digital flow monitor is to monitor and display flow information from remote sensors and provide an output signal.

1 Safety Instructions

These safety instructions are intended to prevent hazardous situations and/or equipment damage. These instructions indicate the level of potential hazard with the labels of "Caution," "Warning" or "Danger." They are all important notes for safety and must be followed in addition to International Standards (ISO/IEC) ¹⁾, and other safety regulations.

¹⁾ ISO 4414: Pneumatic fluid power - General rules relating to systems.

ISO 4413: Hydraulic fluid power - General rules relating to systems.

IEC 60204-1: Safety of machinery - Electrical equipment of machines. (Part 1: General requirements)

ISO 10218-1: Manipulating industrial robots - Safety. etc.

- Refer to product catalogue, Operation Manual and Handling Precautions for SMC Products for additional information.
- Keep this manual in a safe place for future reference.

Caution	Caution indicates a hazard with a low level of risk which, if not avoided, could result in minor or moderate injury.
Warning	Warning indicates a hazard with a medium level of risk which, if not avoided, could result in death or serious injury.
Danger	Danger indicates a hazard with a high level of risk which, if not avoided, will result in death or serious injury.

Warning

- Always ensure compliance with relevant safety laws and standards.**
- All work must be carried out in a safe manner by a qualified person in compliance with applicable national regulations.
- This product is class A equipment intended for use in an industrial environment. There may be potential difficulties in ensuring electromagnetic compatibility in other environments due to conducted or radiated disturbances.
- Refer to the operation manual on the SMC website (URL: <https://www.smcworld.com>) for more safety instructions.

2 Specifications

Model	LFE0#		
Display range (L/min)	0.4 to 24.0 (Displays 0.0 when value is below 0.4)	2.0 to 120.0 (Displays 0.0 when value is below 2.0)	4 to 240 (Displays 0 when value is below 4)
Set point range	0.4 to 24.0 L/min	2.0 to 120.0 L/min	4 to 240 L/min
Min. setting unit	0.1 L/min	0.5 L/min	1 L/min
Accumulated volume per pulse (pulse width =50 ms)	0.1 L/pulse	0.5 L/pulse	1 L/pulse
Display unit	Instantaneous flow L/min, accumulated flow L		
Accuracy	Display value: ±0.5% F.S. Analogue output: ±0.5% F.S.		
Repeatability	±0.5% F.S.		
Temperature characteristics	±0.5% F.S. (25 °C reference)		
Accumulated flow range (L) ¹⁾	99999999.9 by 0.1L	999999999 by 1L	
Switch output	NPN or PNP open collector output		
Max. load current	80 mA		
Max. applied voltage	28 VDC		
Internal voltage drop	NPN: 1 V max. (at 80 mA load current) PNP: 1.5 V max. (at 80 mA load current)		
Response time ²⁾	0.5 s / 1 s / 2 s / 5 s		
Output protection	Short circuit protection		
Output mode	Flow	Hysteresis mode, Window comparator mode, Accumulated output mode or Accumulated pulse output mode	
	Temp	Select the output for fluid temperature (hysteresis mode or window comparator mode).	
Analogue output	Response time ³⁾	0.5 s / 1 s / 2 s / 5 s	
	Voltage output	Output voltage: 1 to 5 V, Output impedance: 1 kΩ min.	
	Current output	Output current : 4 to 20 mA Max. load impedance 600 Ω	
Hysteresis	Variable		
Input and output	Input for copy mode		
Display type	2 screen display (Main screen: 4 digit, 7-segment, 2 colour; red/green, Sub screen: 6 digit, 11 segment, White) Display update interval 5 times/sec.		
Operation LED	Output 1 and 2: Orange		
Power supply voltage	24 VDC ±10%		
Current consumption	50 mA or less		
Connection method	Power supply output 5P connector, sensor 4P connector (e-con)		
Environmental	Enclosure	IP40 (Note that the display front is only certified as IP65 by using optional parts (panel mount adapter and waterproof seal).	
	Operating temperature range	0 to 50°C (No condensation or freezing)	
	Ambient humidity range	Operation, Storage: 35 to 85%RH (No condensation)	
	Withstand voltage	1000 V AC for 1 minute between external terminals and FE	
	Insulation resistance	50 MΩ or more (at 500VDC) between external terminals and case	
Weight	Without lead wire	50 g	
	With lead wire	100 g	

2 Specifications (continued)

*1: The response time will be cleared by turning off the power supply. It is possible to select the function to memorize it. (Every 2 or 5 minutes).

When 5 minutes interval is selected, take into consideration the maximum number of times it is possible to write to the memory device (electronic part), which is 1 million times (5 minutes x 1 million times = 5 million minutes = Approx. 9.5 years for 24 hour energizing). Calculate the life in your operating conditions before using the memorizing function and use within this range.

*2: The response time is when the set value is 63% in relation to the step input. (7 seconds for temperature sensor)

*3: The response time is when the set value reaches 63% in relation to the step input. Linked with the switch output.

2.1 Cable specification

Conductor	Nominal cross section	AWG26
	O.D.	Approx. 0.51 mm
Insulator	Material	Bridge vinyl
	O.D.	Approx. 1.00 mm
	Colours	Brown, blue, black, white, grey
Sheath	Material	Heat and oil resistant plastic
	Cable O.D.	ø3.5 mm

Warning

- Special products (-X) might have specifications different from those shown in this section. Contact SMC for specific drawings.

3 Names of Individual parts

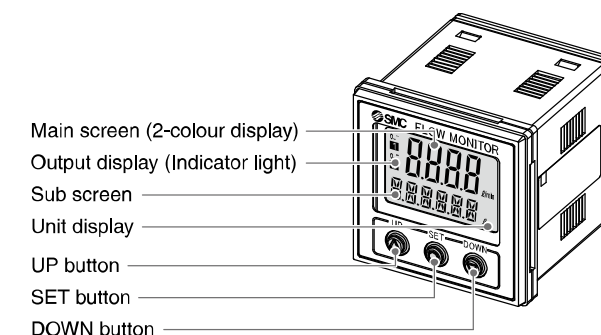

Element	Description
Main screen (2 colour display)	Displays the flow value, setting mode and error codes.
Sub screen	Displays the accumulated flow, set value, peak/bottom value, fluid temperature and line names. In the measurement mode, the set status is displayed.
Output display (Indicator light)	Displays the output status of OUT1 and OUT2. When ON: Orange LED is ON.
Units display	Indicates the unit currently selected.
UP button	Selects the mode and the display shown on the Sub display, or increases the ON/OFF set value.
SET button	Press this button to change the mode and to set a value.
DOWN button	Selects the mode and the display shown on the Sub display, or decreases the ON/OFF set value.

4 Installation

4.1 Installation

Warning

- Do not install the product unless the safety instructions have been read and understood.
- Use the product within the specified operating pressure and temperature range.

4.2 Environment

Warning

- Do not use in an environment where corrosive gases, chemicals, salt water or steam are present.
- Do not use in an explosive atmosphere.
- Do not expose to direct sunlight. Use a suitable protective cover.
- Do not install in a location subject to vibration or impact in excess of the product's specifications.
- Do not mount in a location exposed to radiant heat that would result in temperatures in excess of the product's specifications.

4.3 Mounting with panel mount adapter

- The flow monitor can be fixed to the panel with the panel mount adapter using the screws supplied M3 x 8 L (2 pcs.). Panel mount adapter (Part number: ZS-26-B) Front protective cover (Part number: ZS-26-01)
- The panel mount adapter can be rotated through 90 degrees for mounting.
- The panel mount adapter should be fixed firmly with screws. Otherwise, fluids such as water may enter. After contact with the panel, further tighten screws by 1/4 to 1/2 turn.

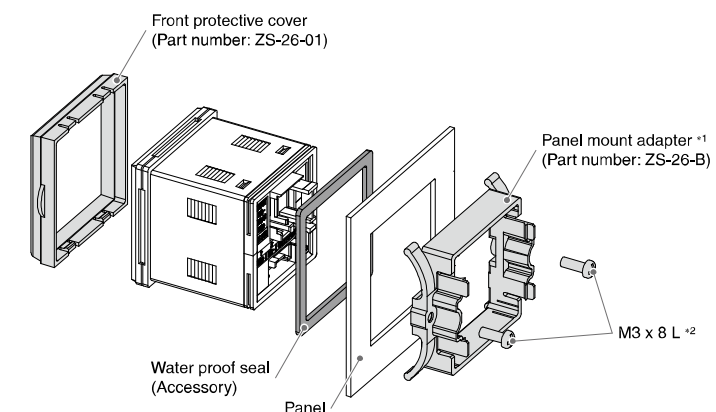

4.4 Removal of panel mount adapter

The flow monitor with panel mount adapter can be removed from the panel after removing the two screws, and by disconnecting the hooks on both sides.

This can be done by inserting a suitable piece of thin card. Pull the panel mount adapter to the front and remove the flow monitor. If the panel mount adapter is pulled forward with the hook caught, the product and the adapter may be damaged.

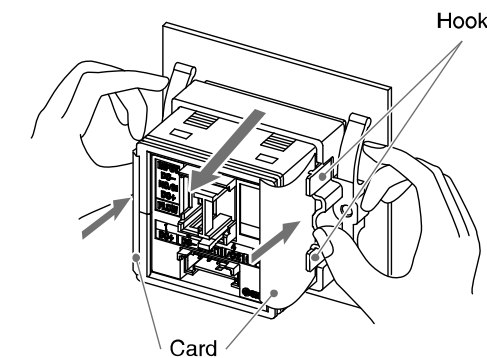

4 Installation (continued)

4.5 Wiring

Caution

- Do not perform wiring while the power is on.
- Confirm proper insulation of wiring.
- Do not route wires and cables together with power or high voltage cables.

Otherwise the product can malfunction due to interference of noise and surge voltage from power and high voltage cables to the signal line.

- Keep wiring as short as possible to prevent interference from electromagnetic noise and surge voltage.
- Ensure that the FG terminal is connected to ground when using a commercially available switch-mode power supply.

Switching noise will be superimposed and the product specification can no longer be met. This can be prevented by inserting a noise filter, such as a line noise filter and ferrite core, between the switch-mode power supply and the product, or by using a series power supply instead of a switch-mode power supply.

Connection of Sensor and Power supply connectors

- When connecting, insert the connectors straight into the body until it clicks.
- To remove the connectors, press down the lever to release the hook from the housing and pull the connectors out straight.

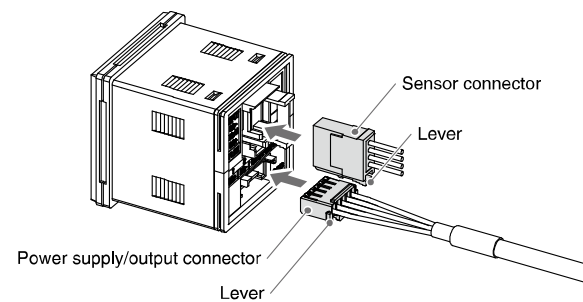

4.6 Sensor Connector

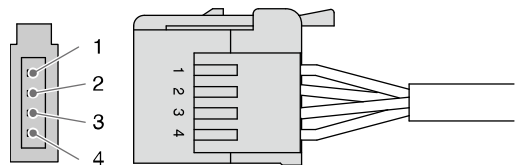

Pin No.	Description	Wire colour
1	DC (+)	Brown
2	N.C./ IN: Unused (do not connect wire)	-
3	DC (-)	Blue
4	INPUT : (flow sensor 1 to 5 V)	White

Wiring of the Sensor connector

- Strip the sensor lead wire as shown in the figure. (Refer to the following table for the connector and applicable wire).
- Do not cut the insulator.

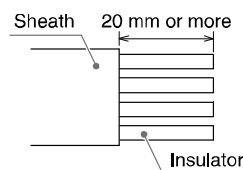

SMC part No. (1 pc.)	Colour of cover	Insulator outside diameter
ZS-28-CA-5 (included with product)	Grey	φ1.6 to φ2.0

4 Installation (continued)

- The core of the corresponding colour shown in the table below is put into the pin of the number marked on the connector for sensor connection.

Pin No.	Wire colour *
1	Brown
2	-
3	Blue
4	White

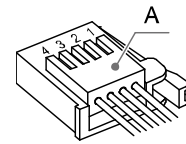

* When using the lead wire with M12 connector included with the LFE series.

- Ensure that the above-mentioned preparation work has been performed correctly, and press part "A" by hand to make temporary connection.
- Press part "A" centre straight in using a suitable tool, such as pliers.
- The sensor connector cannot be re-used once crimped.
- For a connection failure such as incorrect order of wire or incomplete insertion, use a new connector.
- When the sensor is not connected correctly, "LLL" will be displayed.

4.7 Power Supply Connector

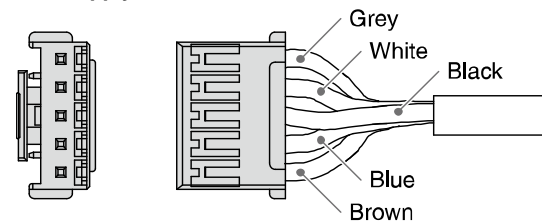

Description	Wire colour
COPY	Grey
OUT2	White
OUT1	Black
DC (-)	Blue
DC (+)	Brown

5 Flow Setting

5.1 Measurement mode

The mode in which the flow is detected and displayed, and the switch function is operating.

This is the basic operating mode; other modes should be selected for set-point and other function setting changes.

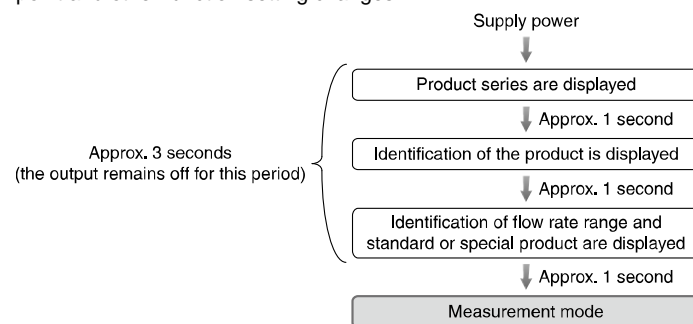

5.2 Switch operation

When the flow exceeds the set value, the switch will be turned ON.

When the flow falls below the set value by the amount of hysteresis or more, the switch will be turned OFF.

If the operation shown is acceptable, keep this setting.

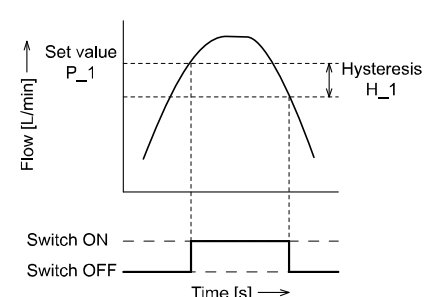

6 Setting mode

Be sure to select the required sensor to be connected.

- Press the SET button in measurement mode to display set values. [P_1] or [n_1] and the set value are displayed alternately.

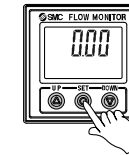

- Press the UP or DOWN button to change the set value. The UP button is to increase and the DOWN button is to decrease.

- Press the UP button once to increase by one digit, or press and hold to continuously increase.

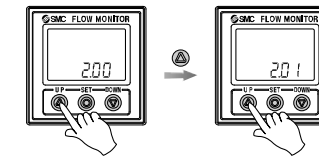

- Press the DOWN button once to decrease by one digit, or press and hold to continuously decrease.

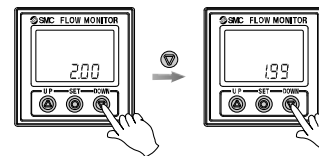

- Press the SET button to finish the setting.

The Flow switch turns on within a set flow range (P1L to P1H) during window comparator mode. Set P1L (switch lower limit) and P1H (switch upper limit) using the above setting procedure. When reversed output is selected, the main screen displays [n1L] and [n1H].

For models with 2 outputs [P_2] or [n_2] will be displayed. Set as above. For more detailed settings, set each function in Function selection mode while referring to the operation manual.

7 Function Settings

7.1 Function selection mode

In measurement mode, press the SET button for 2 seconds or longer to display [F 0].

Select to display the function to be change [F□□].

Press and hold the SET button for 2 seconds or longer to return to measurement mode.

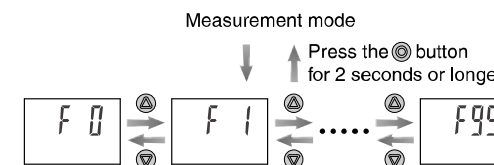

The function number is increased and decreased by the UP and DOWN buttons. Display the required function number and press the SET button.

7.2 Sub screen display

In measurement mode, the sub screen display can be temporarily changed by pressing the UP or DOWN buttons.

After 30 seconds, it will automatically reset to the display selected in [F10]. Example shown is for the 4 L/min type.

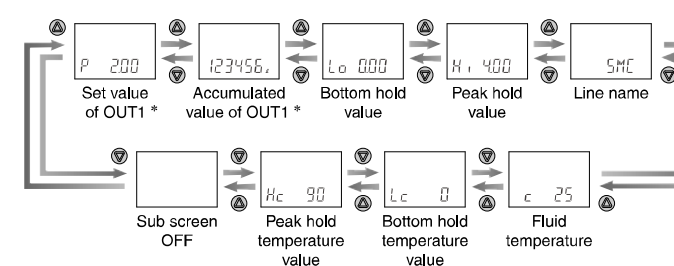

7 Function Settings (continued)

7.3 Default function settings

- [F 0] Selection of sensor

Item	Description	Default setting
Range selection of connected sensor.	The flow rate range of the sensor to be connected is set.	Rated flow rate 20 L/min type

- [F 1] Setting of OUT1

Item	Description	Default setting
Output mode	Select the switch output type from: Instantaneous flow (either hysteresis or window comparator mode), accumulated flow, accumulated pulse.	Hysteresis mode
Reversed output	Select which type of switch output is to be used, normal or reversed.	Normal output
Set value	Set the ON and OFF point of the switch output	50% of rated flow
Hysteresis	Setting of hysteresis can prevent chattering.	5% of rated flow
Display colour	Select the colour of the main display.	Output ON: Green Output OFF: Red

- [F 2] Setting of OUT2

Item	Description	Default setting
Output mode	Selects the switch output type from: Instantaneous flow (either hysteresis or window comparator mode), accumulated flow, accumulated pulse or fluid temperature (either hysteresis mode or window comparator mode).	Hysteresis mode for instantaneous flow
Reversed output	Selects which type of switch output is to be used, normal or reversed.	Normal output
Set value	Sets the ON and OFF point of the switch output	50% of rated flow
Hysteresis	Setting of hysteresis can prevent chattering.	5% of rated flow

- Other parameter settings

Item	Default setting
[F3] Response time	1 second
[F10] Sub screen	Display of set value
[F20] Setting of external input	-
[F22] Analogue output	Free range analogue output for instantaneous flow: OFF
[F30] Storing of accumulated flow	OFF
[F80] Power saving mode	OFF (display is ON)
[F81] Setting of security code	OFF
[F82] Input of line names	No name
[F90] Setting of all functions	OFF
[F96] Input value check	Display of input voltage (sensor output voltage)
[F97] Selection of copy function	OFF
[F98] Output check	OFF
[F99] Reset to default settings	OFF

8 Other Settings

- Key-lock function

Refer to the operation manual on the SMC website (URL: <https://www.smcworld.com>) for setting these functions.

9 How to Order

Refer to the operation manual or catalogue on the SMC website (URL: <https://www.smcworld.com>) for How to order information.

10 Outline Dimensions (mm)

Refer to the operation manual or catalogue on the SMC website (URL: <https://www.smcworld.com>) for Outline Dimensions.

11 Troubleshooting

11.1 Error indication

Error	Error displayed	Description	Countermeasures
OUT1 over current error	Er 1	A load current of 80 mA or more is flowing to the switch output (OUT1).	Turn the power off and remove the cause of the over current.
OUT2 over current error	Er 2	A load current of 80 mA or more is flowing to the switch output (OUT2).	Then turn the power on again.
Excessive instantaneous flow	HHH	The applied flow rate is above approx. 120% of maximum rated flow.	Reset applied flow to a level within the display range.
Sensor disconnection error	LLL	The remote sensor is not connected to the monitor, or the sensor output is below 0.6 V.	Connect the sensor or check the sensor output voltage. If a sensor is connected, check that the flow direction is correct.
Excessive accumulated flow		The accumulated flow range is exceeded. (in some flow ranges, the decimal point may flash).	Reset the accumulated flow.
System error	Er 0 Er 4 Er 6 Er 8	Displayed if an internal data error has occurred.	Turn the power off and turn it on again. If the failure cannot be solved, contact SMC for repair.

If the error cannot be reset after the above measures are taken, or errors other than the above are displayed, please contact SMC.

Refer to the operation manual on the SMC website (URL: <https://www.smcworld.com>) for more detailed information about troubleshooting.

12 Maintenance

12.1 General Maintenance

Caution

- Not following proper maintenance procedures could cause the product to malfunction and lead to equipment damage.
 - If handled improperly, compressed air can be dangerous.
 - Maintenance of pneumatic systems should be performed only by qualified personnel.
 - Before performing maintenance, turn off the power supply and be sure to cut off the supply pressure. Confirm that the air is released to atmosphere.
 - After installation and maintenance, apply operating pressure and power to the equipment and perform appropriate functional and leakage tests to make sure the equipment is installed correctly.
 - If any electrical connections are disturbed during maintenance, ensure they are reconnected correctly and safety checks are carried out as required to ensure continued compliance with applicable national regulations.
 - Do not make any modification to the product.
 - Do not disassemble the product, unless required by installation or maintenance instructions.
- **How to reset the product after a power cut or when the power has been unexpectedly removed**
The settings of the product are retained from before the power cut or de-energizing.
The output condition also recovers to that before the power cut or de-energizing, but may change depending on the operating environment. Therefore, check the safety of the whole system before operating the product.

13 Limitations of Use

8.1 Limited warranty and Disclaimer/Compliance Requirements

Refer to Handling Precautions for SMC Products.

14 Product disposal

This product should not be disposed of as municipal waste. Check your local regulations and guidelines to dispose of this product correctly, in order to reduce the impact on human health and the environment.

15 Contacts

Refer to www.smcworld.com or www.smc.eu for your local distributor / importer.

SMC Corporation

URL : <https://www.smcworld.com> (Global) <https://www.smceu.com> (Europe)
SMC Corporation, 4-14-1, Sotokanda, Chiyoda-ku, Tokyo 101-0021, Japan
Specifications are subject to change without prior notice from the manufacturer.
© 2021 SMC Corporation All Rights Reserved.
Template DKP50047-F-085M