

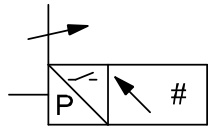

ORIGINAL INSTRUCTIONS

Instruction Manual
High Precision Digital Pressure Switch
Series ZSE10(F) / ISE10



The intended use of this digital pressure switch is to measure, monitor and display pressure and to provide an output signal.

1 Safety Instructions

These safety instructions are intended to prevent hazardous situations and/or equipment damage. These instructions indicate the level of potential hazard with the labels of "Caution," "Warning" or "Danger." They are all important notes for safety and must be followed in addition to International Standards (ISO/IEC)⁽¹⁾, and other safety regulations.

- ⁽¹⁾ ISO 4414: Pneumatic fluid power - General rules relating to systems.
- ISO 4413: Hydraulic fluid power - General rules relating to systems.
- IEC 60204-1: Safety of machinery - Electrical equipment of machines. (Part 1: General requirements)
- ISO 10218-1: Robots and robotic devices - Safety requirements for industrial robots - Part 1: Robots.

- Refer to product catalogue, Operation Manual and Handling Precautions for SMC Products for additional information.
- Keep this manual in a safe place for future reference.

	Caution	Caution indicates a hazard with a low level of risk which, if not avoided, could result in minor or moderate injury.
	Warning	Warning indicates a hazard with a medium level of risk which, if not avoided, could result in death or serious injury.
	Danger	Danger indicates a hazard with a high level of risk which, if not avoided, will result in death or serious injury.

Warning

- Always ensure compliance with relevant safety laws and standards.
- All work must be carried out in a safe manner by a qualified person in compliance with applicable national regulations.
- This product is class A equipment intended for use in an industrial environment. There may be potential difficulties in ensuring electromagnetic compatibility in other environments due to conducted or radiated disturbances. Otherwise electric shock, malfunction or product damage can result.
- Refer to the operation manual on the SMC website (URL: <https://www.smcworld.com>) for more safety instructions.

2 Specifications

2.1 General specifications

Model No.	ZSE10 Vacuum	ZSE10F Compound	ISE10 Positive	
Applicable fluid	Air, inert gases, non-combustible gases			
Pressure	Rated pressure range	0.0 to -101.0 kPa	-100.0 to 100.0 kPa	-0.100 to 1.000 MPa
	Set pressure range	10.0 to -105.0 kPa	-105.0 to 105.0 kPa	-0.105 to 1.050 MPa
	Withstand pressure	500 kPa		1.5 MPa
	Minimum Display unit	0.1 kPa		0.001 MPa
Power supply	Power supply voltage	12 to 24 VDC (±10%), ripple 10% (p-p) max.		
	Current consumption	40 mA or less		
	Protection	Polarity protection		
Switch output	Output type	NPN or PNP open collector: 2 outputs		
	Maximum load current	80 mA		
	Maximum applied voltage	28 V (for NPN output)		
	Residual voltage	2 V or less (at 80 mA load current)		
	Response time	2.5 ms or less (anti-chatter function: 20, 100, 500, 1000, 2000 ms)		
	Protection	Short circuit protection		
Repeatability	±0.2% F.S. ±1 digit			
Hysteresis	Hysteresis mode	0 to variable		
	Window comparator mode			
Analogue	Analogue Voltage output	1 to 5 V ±2.5% F.S.	0.6 to 5 V ±2.5% F.S.	
	Linearity	±1% F.S.		
	Output impedance	1 kΩ approx.		
Display	Display	3 1/2 digits, 7-segment display, colour (red)		
	Display accuracy	±2% F.S. ±1 digit (at ambient temperature 25±3 °C)		
	Indicator light	LED is ON when output is ON (OUT1: Green, OUT2: Red)		
Digital filter *4	0, 10, 50, 100, 500, 1000, 5000 ms			
Environment	Enclosure	IP40		
	Ambient temperature range	Operation: -5 to 50 °C, Storage: -10 to 60 °C (no condensation or freezing)		
	Ambient humidity range	Operation, Storage: 35 to 85%RH (no condensation)		
	Withstand voltage	1000 VAC for 1 minute between terminals and housing		
	Insulation resistance	50 MΩ or more at 500 VDC between terminals and housing		
Temperature characteristics	±2% F.S. (25 °C reference)			
Lead wire	Oil resistant vinyl cabtyre cable 5 cores φ3.5 mm, 2 m long Sectional area of conductor: 0.15 mm ² (AWG26) Outside diameter of insulator: 1.0 mm			

* If the applied pressure fluctuates around the set value, the hysteresis must be set to a value more than the amount of fluctuation or chattering will occur.

2.2 Piping / Weight specifications

Model No.	M5	M5R	01	N01
Port size	M5 x 0.8	M5 x 0.8	R1/8 M5 (0.8)	NPT1/8 M5 (0.8)
Materials	Pressure-sensing part	Silicon		
	Piping port	C3602 (electroless nickel plating), O-ring: HNBR		
Weight	Without lead wire	15 g	23 g	
	With lead wire and connector	55 g	63 g	

Warning

Special products (-X) might have specifications different from those shown in this section. Contact SMC for specific drawings.

3 Name and function of product parts

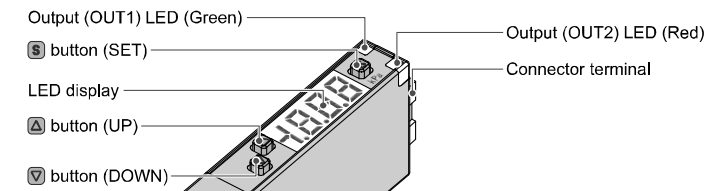

Output (OUT1) LED (Green): LED is ON when the switch output (OUT1) is ON.

Output (OUT2) LED (Red): LED is ON when the switch output (OUT2) is ON.

LED display: Displays the current status of pressure, setting mode and error code.

▲ button (UP): Selects the mode or increases the ON/OFF set value. Press this button to change to peak display mode.

▼ button (DOWN): Selects the mode or decreases the ON/OFF set value. Press this button to change to bottom display mode.

Ⓢ button (SET): Press this button to change to another mode and to set a value.

4 Installation

4.1 Installation

Warning

Do not install the product unless the safety instructions have been read and understood.

4.2 Direct Mounting

- Mount using the M3 set screws (2 pcs.) supplied for direct mounting. Required tightening torque is 0.5 to 0.7 N•m.

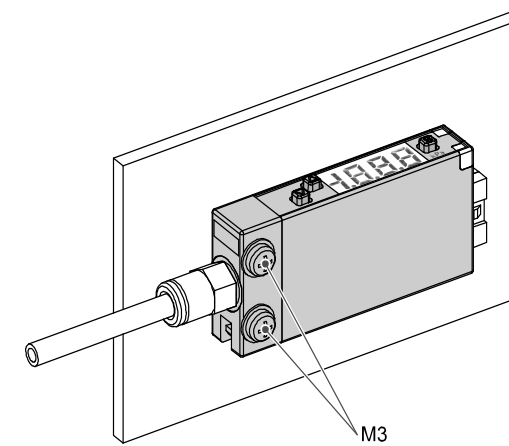

4 Installation (continued)

4.3 Mounting with panel mount adapter

- Panel mount adapter (Part No.: ZS-39-B)
- Front protective cover (Part No.: ZS-39-01)
- Panel mount adapter + Front protective cover (Part No.: ZS-39-D)

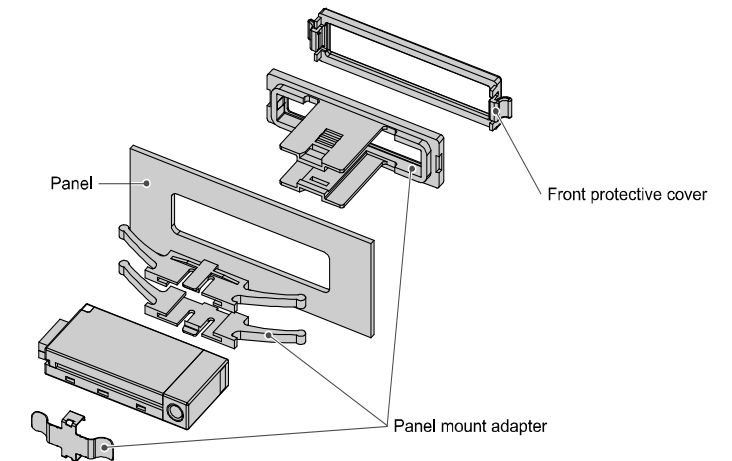

4.4 Mounting with DIN rail adapter

- Prepare a DIN rail adapter for mounting on the DIN rail (Part No.: ZS-39-R).
- Take care not to bend the claws of the DIN rail adapter when mounting.

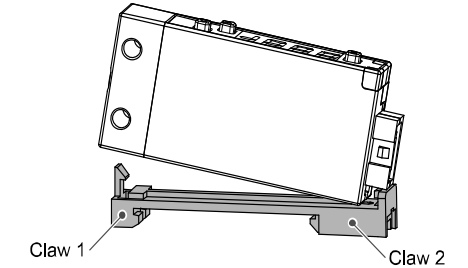

Mounting on to the DIN rail

Engage the Pressure switch with claw 2 of the DIN rail adapter, then press down on to claw 1 until it clicks.

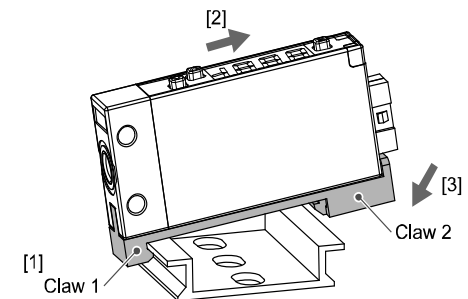

Engage claw 1 of the adapter on to the DIN rail as shown [1], apply force in direction [2], then press downward [3] until claw 2 clicks on to the DIN rail.

Removal from DIN rail

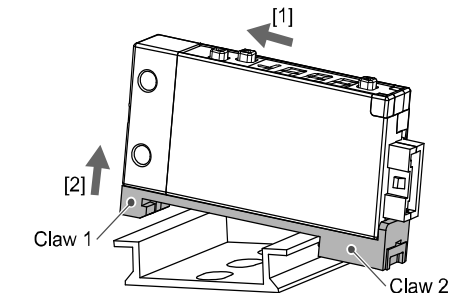

Move in the direction [1], then remove claw 1 in direction [2] as shown.

4 Installation (continued)

4.5 Environment

Warning

- Do not use in an environment where corrosive gases, chemicals, salt water or steam are present.
- Do not use in an explosive atmosphere.
- Do not expose to direct sunlight. Use a suitable protective cover.
- Do not install in a location subject to vibration or impact. Check the product specifications.
- Do not mount in a location exposed to radiant heat.
- Do not use in a place where electrostatic charge will be a problem.

4.6 Piping

Caution

- Before piping make sure to clean up chips, cutting oil, dust etc.
- When installing piping or fittings, ensure sealant material does not enter inside the port. When using seal tape, leave 1 thread exposed on the end of the pipe/fitting.
- Tighten fittings to the specified tightening torque.

4.6.1 Tightening torque for piping

The required tightening torque of the piping port is 1 N•m for M5 thread. (equivalent to approximately 1/6 extra tightening after manual tightening) and 7 to 9 N•m for R1/8 and NPT1/8 threads.

4.6.2 Connection using One-touch fitting

- Cut the tube end perpendicular.
 - Hold the tube and insert it into the One-touch fitting slowly until it bottoms out.
- Allow sufficient tube length to prevent twist and tensile or moment loads from being applied to the fitting or tube.
 - When using a tube manufactured by a company other than SMC, check that its outside diameter tolerance satisfies the following values:
 - Nylon tube: ±0.1 mm maximum
 - Soft nylon tube: ±0.1 mm maximum
 - Polyurethane tube: +0.15 mm / -2 mm maximum

4.7 Lubrication

Caution

- SMC products have been lubricated for life at manufacture, and do not require lubrication in service.
- If a lubricant is used in the system, use turbine oil Class 1 (no additive), ISO VG32. Once lubricant is used in the system, lubrication must be continued because the original lubricant applied during manufacturing will be washed away.

5 Wiring

5.1 Wiring connections

- Connections should be made with the power supply turned off.
- Use a separate route for the product wiring and any power or high voltage wiring. Otherwise, malfunction may result due to noise.
- Ensure that the FG terminal is connected to ground when using a commercially available switch-mode power supply. When a switch-mode power supply is connected to the product, switching noise will be superimposed and the product specification can no longer be met. This can be prevented by inserting a noise filter, such as a line noise filter and ferrite core, between the switch-mode power supply and the product, or by using a series power supply instead of a switch-mode power supply.

5 Wiring (continued)

5.2 Connector attaching / detaching

- When mounting the connector, insert it straight into the socket, holding the lever and connector body, and push the connector until the lever hooks into the housing, and locks.
- When removing the connector, press down the lever to release the hook from the housing and pull the connector straight out.

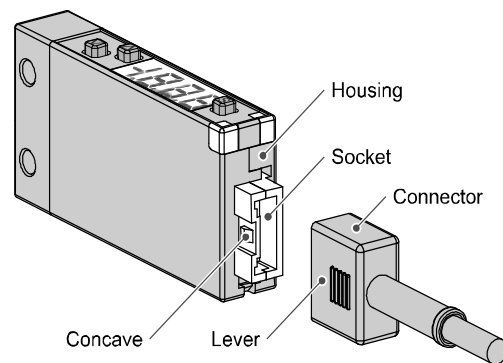

Connector pin numbers

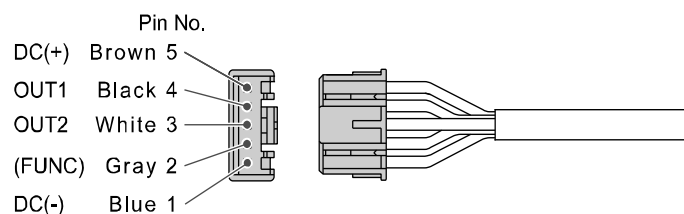

6 Pressure Setting

6.1 Measurement mode

Measurement mode is the condition where the pressure is detected and displayed, and the switch function is operating. This is the basic mode, and other modes should be selected for setting changes and function settings.

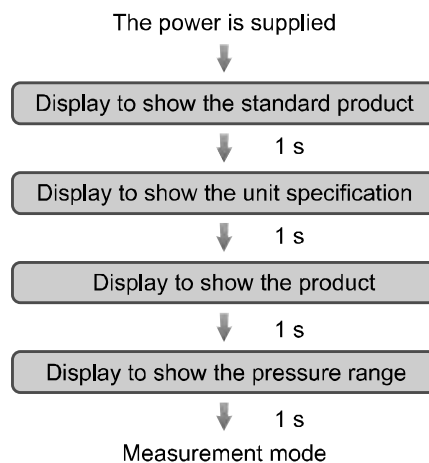

6.2 Setting the ON and OFF points of the Pressure switch

When the pressure exceeds the set value, the Pressure switch will turn ON. When the pressure falls below the set value by the amount of hysteresis or more, the Pressure switch will turn OFF. The default setting of the output set value is the central value between the atmospheric pressure and the upper limit of the rated pressure range.

6 Pressure Setting (continued)

If this condition, shown below, is acceptable, then keep these settings.

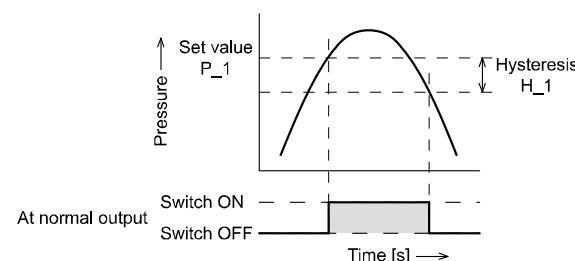

<Operation>

[Hysteresis mode]

- Press the SET button once in measurement mode.

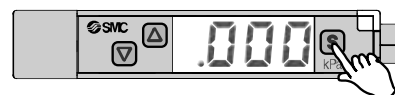

- [P_1] or [n_1] and the set value are displayed in turn.

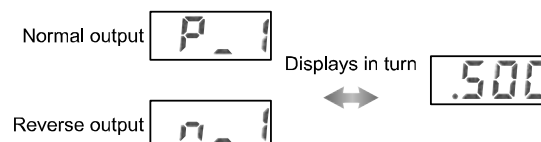

- Press the UP or DOWN button to change the set value. The UP button is to increase and the DOWN button is to decrease.
 - Press the UP button once to increase by one digit and press it continuously to keep increasing the set value.
 - Press the DOWN button once to decrease by one digit and press it continuously to keep decreasing the set value.

- Press the SET button to finish the setting. For models with 2 outputs, [P_2] or [n_2] will be displayed. Set as above.

The Pressure switch operates within a set pressure range (from P1L to P1H) during window comparator mode. Set P1L (switch lower limit) and P1H (switch upper limit) using the setting procedure above. When reversed output is selected, [n1L] and [n1H] are displayed.

6.3 Zero clear of Display

The display is reset to zero when the UP and DOWN buttons are pressed simultaneously for 1 second. For the first operation, always perform zero clear with no pressure applied.

7 Function Setting

In measurement mode, press the SET button for 2 seconds or longer to display [F 0]. Select to display the function to be changed [F]. Press the SET button for 2 seconds or longer to return to measurement mode.

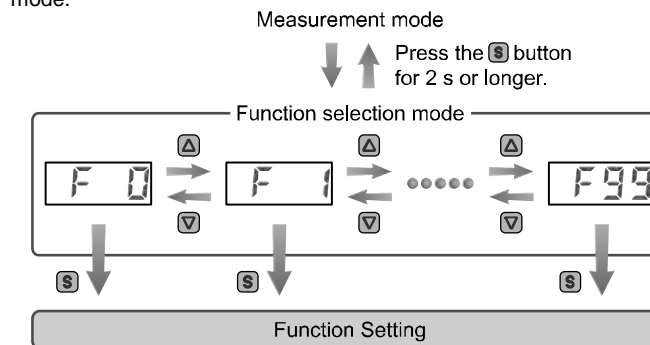

Note: Some functions are not available depending on part number. All functions are displayed with [F] followed by the function description. If a function is not available, the function is displayed as [--].

7.1 Default Function settings

At the time of shipment, the following settings are provided. If this condition is acceptable, then keep these settings. To change the settings, enter function selection mode.

Units specification	Pressure range	Default setting
"Nil" or M	ISE10	MPa
	ZSE10(F)	kPa
P	ISE10	psi
	ZSE10(F)	

• F 1] Setting of OUT1

Item	Description	Default setting
Output mode	Select hysteresis mode, window comparator mode or OFF mode.	Hysteresis mode
Reversed output	Select reversed output.	Normal output
Pressure setting	Set the ON or OFF point of the switch output	ISE10: 0.500 MPa ZSE10: -50.5 kPa ZSE10F: 50.0 kPa
Hysteresis	Set the hysteresis to prevent chattering.	ISE10: 0.050 MPa ZSE10: 5.1 kPa ZSE10F: 5.0 kPa

- [F 2] Setting of OUT2 is the same setting as [F 1] OUT1.

• Other parameter settings

Item	Default setting
[F 3] Response time	2.5 ms
[F 4] Auto-preset function	Manual
[F 6] Fine adjustment of display value	0%
[F11] Display resolution	1000-split
[F80] Power saving mode	OFF
[F81] Security code	OFF
[F90] Setting of all functions	OFF
[F97] Copy function	OFF
[F98] Check of output	Normal
[F99] Reset to the default setting	OFF

8 Other Settings

- Peak/bottom value indication
- Zero clear function
- Key-lock function

For further details refer to the operation manual on the SMC website (URL: <https://www.smcworld.com>).

9 How to Order

Refer to the operation manual or catalogue on the SMC website (URL: <https://www.smcworld.com>) for How to order information.

10 Outline Dimensions

Refer to the operation manual or catalogue on the SMC website (URL: <https://www.smcworld.com>) for Outline Dimensions.

11 Error indication

Error Name	Error Display	Error Type	Troubleshooting Method
Over current Error	Er 1 Er 2	The switch output load current is more than 80 mA.	Turn the power OFF and remove the cause of the over current. Then turn the power ON.
Zero clear Error	Er 3	During zero clear operation, pressure above $\pm 7\%$ F.S. ($\pm 3.5\%$ F.S. for compound pressure) is applied. After 1 second, the mode will return to measurement mode. The zero clear range can vary $\pm 1\%$ F.S. with individual product differences.	Perform zero clear operation again after restoring the applied pressure to an atmospheric pressure condition.
Pressurize Error	HHH	Pressure has exceeded the upper limit of the set pressure range.	Adjust the applied pressure to a level within the set pressure range.
	LLL	Pressure is below the lower limit of the set pressure range.	
System Error	Er 0 Er 4 Er 6 Er 7 Er 8 Er 9	Displayed in the case of an internal data error.	Turn the power off and turn it on again. If resetting fails, an investigation by SMC Corporation will be required.

If the error cannot be reset after the above measures are taken, then please contact SMC.

12 Maintenance

12.1 General Maintenance

⚠ Caution

- Not following proper maintenance procedures could cause the product to malfunction and lead to equipment damage.
- If handled improperly, compressed air can be dangerous.
- Maintenance of pneumatic systems should be performed only by qualified personnel.
- Before performing maintenance, turn off the power supply and be sure to cut off the supply pressure. Confirm that the air is released to atmosphere.
- After installation and maintenance, apply operating pressure and power to the equipment and perform appropriate functional and leakage tests to make sure the equipment is installed correctly.
- If any electrical connections are disturbed during maintenance, ensure they are reconnected correctly and safety checks are carried out as required to ensure continued compliance with applicable national regulations.
- Do not make any modification to the product.
- Do not disassemble the product, unless required by installation or maintenance instructions.

13 Limitations of Use

13.1 Limited warranty and Disclaimer/Compliance Requirements

Refer to Handling Precautions for SMC Products.

⚠ Caution

- **SMC products are not intended for use as instruments for legal metrology.**
Measurement instruments that SMC manufactures or sells have not been qualified by type approval tests relevant to the metrology (measurement) laws of each country. Therefore, SMC products cannot be used for business or certification ordained by the metrology (measurement) laws of each country.

14 Product disposal

This product shall not be disposed of as municipal waste. Check your local regulations and guidelines to dispose of this product correctly, in order to reduce the impact on human health and the environment.

15 Contacts

Refer to www.smcworld.com or www.smc.eu for your local distributor / importer.

SMC Corporation

URL: <https://www.smcworld.com> (Global) <https://www.smc.eu> (Europe)
SMC Corporation, 4-14-1, Sotokanda, Chiyoda-ku, Tokyo 101-0021, Japan
Specifications are subject to change without prior notice from the manufacturer.
© 2021 SMC Corporation All Rights Reserved.
Template DKP50047-F-085M